



28V-Input-Voltage Single-Cell Li-Ion Battery Charger with 10mA Regulator

The 34675 is a high-input-voltage Li-Ion battery charger with a 4.85V/10mA linear regulator. The high input voltage, up to 28V, eliminates the input over-voltage protection circuit required in handheld devices such as cell phones, Bluetooth accessories, and portable media players. The 4.85V linear regulator is capable of 10mA output current and can be used to directly power a sub-system such as a USB transceiver.

The charge cycle of the 34675 includes trickle, constant-current (CC) and constant-voltage (CV) charge modes. The CC mode current is programmable up to 1A, with an external resistor. The voltage across the external resistor is also used to monitor the actual charge current. The constant voltage is fixed at 4.2V with 0.7% accuracy over the -40°C to 85°C temperature range. The trickle-mode current is pre-set to 20% of the CC mode current when the battery voltage is lower than the trickle-mode threshold. The end-of-charge (EOC) current threshold is pre-set to 10% of the CC mode current, to save board space and cost. A charge current thermal foldback feature limits the charge current when the IC internal temperature rises to the preset threshold of 120°C. The 34675 also protects the system with its input over-voltage protection (OVP) feature. Two indication pins ($\overline{\text{PPR}}$ and $\overline{\text{CHG}}$) can be simply interfaced to a microprocessor or LEDs. When no power supply is connected, or when disabled, the charger draws less than 1.0 μ A leakage current from the battery.

34675

POWER MANAGEMENT IC



ORDERING INFORMATION		
Device	Temperature Range (T _A)	Package
MC34675AEP/R2	-40°C to 85°C	8-UDFN

Features

- No external MOSFET, reverse-blocking diode, or current-sense resistor is required
- Guaranteed maximum 1A programmable CC mode current
- $\pm 0.7\%$ voltage accuracy over -40°C to 85°C
- $\pm 6\%$ current accuracy over -40°C to 85°C
- 4.85V/10mA linear regulator with a 6.8V input over-voltage protection threshold
- 28V maximum voltage for the power input with a 6.8V over-voltage protection threshold
- Trickle charge for fully discharged batteries
- Charge current monitor
- Charge current thermal foldback
- Pb-free packaging designated by suffix code EP

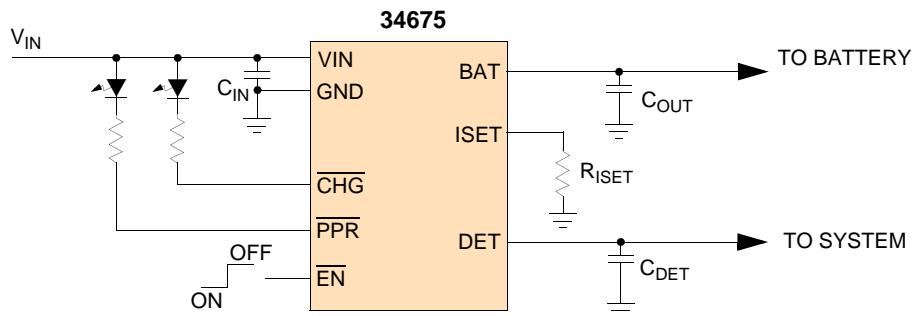

Figure 1. 34675 Simplified Application Diagram

* This document contains certain information on a new product. Specifications and information herein are subject to change without notice.

INTERNAL BLOCK DIAGRAM

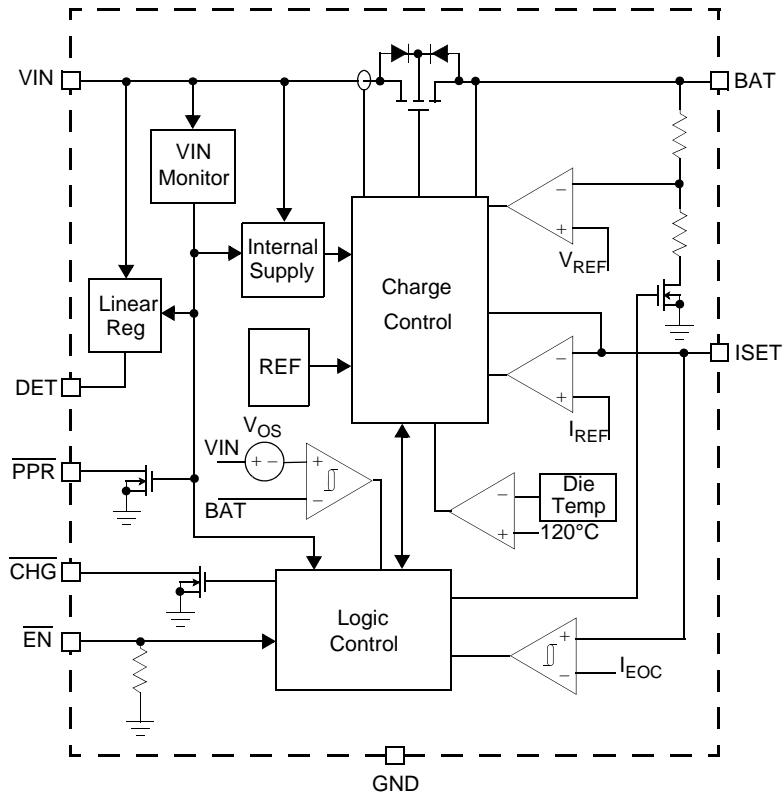

Figure 2. 34675 Simplified Internal Block Diagram

PIN CONNECTIONS

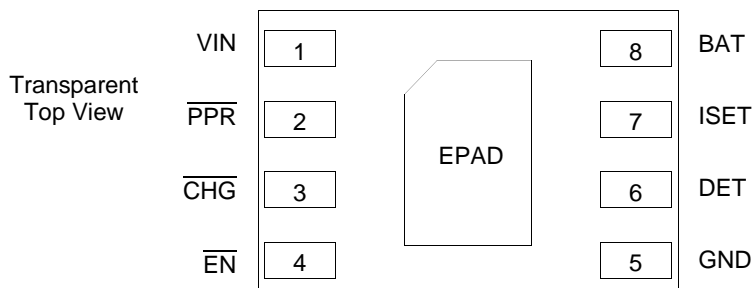

Figure 3. 34675 Pin Connections

Table 1. 34675 Pin Definitions

A functional description of each pin can be found in the Functional Pin Description section beginning on [page 12](#).

Pin Number	Pin Name	Pin Function	Formal Name	Definition
1	VIN	Input	Input supply	The power supply input.
2	PPR	Output	Power present indicator	Indication of the input power status. Open drain output.
3	CHG	Output	Charge indicator	Indication of the charge status. Open drain output.
4	EN	Input	Enable	Enable logic input.
5	GND	Ground	Ground	Ground.
6	DET	Output	Regulator output	The 4.85V/10mA linear regulator output.
7	ISET	Output	CC mode current setting and charge current monitor	CC mode current setting and charge current monitoring pin.
8	BAT	Output	Charger output	The charger output pin. Connect this pin to the Li-Ion battery.
EPAD	EPAD	N/A	Exposed pad	The exposed pad for thermal dissipation enhancement. It must be soldered on the large ground plane on the PCB to increase the thermal dissipation. The pad must be connected to GND electrically

ELECTRICAL CHARACTERISTICS

MAXIMUM RATINGS

Table 2. Maximum Ratings

All voltages are with respect to ground unless otherwise noted. Exceeding these ratings may cause a malfunction or permanent damage to the device.

Ratings	Symbol	Value	Unit
ELECTRICAL RATINGS			
Input Voltage Range VIN Pin PPR and CHG Pins EN, BAT, ISET and DET Pins	V _{IN} V _{PPR} , V _{CHG} V _{EN} , V _{BAT} , V _{ISET} , V _{DET}	-0.3 to 28 -0.3 to 12 -0.3 to 5.5	V
ESD Voltage ⁽¹⁾ Human Body Model (HBM) Machine Model (MM)	V _{ESD}	±2000 ±200	V
THERMAL RATINGS			
Operating Temperature Ambient Junction	T _A T _J	-40 to +85 -40 to 150	°C
Storage Temperature	T _{STG}	-65 to +150	°C
Thermal Resistance ⁽²⁾ Junction-to-Case Junction-to-Ambient	R _{θJC} R _{θJA}	10 70	°C/W
Peak Package Reflow Temperature During Reflow ^{(3),(4)}	T _{PPRT}	Note 4	°C

Notes

- ESD testing is performed in accordance with the Human Body Model (HBM) (C_{ZAP} = 100pF, R_{ZAP} = 1500Ω), and the Machine Model (MM) (C_{ZAP} = 200pF, R_{ZAP} = 0Ω).
- Device mounted on the Freescale EVB test board per JEDEC DESD51-2.
- Pin soldering temperature limit is for 10 seconds maximum duration. Not designed for immersion soldering. Exceeding these limits may cause malfunction or permanent damage to the device.
- Freescale's Package Reflow capability meets Pb-free requirements for JEDEC standard J-STD-020C. For Peak Package Reflow Temperature and Moisture Sensitivity Levels (MSL), Go to www.freescale.com, search by part number [e.g. remove prefixes/suffixes and enter the core ID to view all orderable parts. (i.e. MC33xxx enter 33xxx), and review parametrics.

STATIC ELECTRICAL CHARACTERISTICS

Table 3. Static Electrical Characteristics

Characteristics noted under conditions $V_{IN} = 5V$, $-40^{\circ}C \leq T_A \leq 85^{\circ}C$, $C_{IN} = 1.0\mu F$, $C_{OUT} = 2.2\mu F$, $C_{DET} = 0.22\mu F$ (see [Figure 1](#)), unless otherwise noted. Typical values noted reflect the approximate parameter means at $V_{IN} = 5V$ and $T_A = 25^{\circ}C$ under nominal conditions, unless otherwise noted.

Characteristic	Symbol	Min	Typ	Max	Unit
POWER INPUT					
VIN Pin Normal Operation Input Voltage Range ⁽⁵⁾	V_{IN}	2.6	-	6.6	V
VIN Pin Supply Current	I_{IN}				μA
Charger enabled ⁽⁶⁾		-	1400	2000	
Charger disabled		-	360	450	
Regulated Output Voltage	V_{BAT}				V
$V_{IN} = 5.0V$; $I_{BAT} = 10mA$; $T_A = 25^{\circ}C$		4.185	4.20	4.215	
$V_{IN} = 5.0V$; $I_{BAT} = 10mA$; $T_A = -40$ to $85^{\circ}C$		4.170	4.20	4.230	
Power MOSFET On Resistance	$R_{DS(ON)}$				$m\Omega$
$V_{BAT} = 4.0V$; $I_{BAT} = 400mA$; $I_{CHG} = 500mA$		-	330	475	
BAT Pin Standby Current	I_{STDBY}				μA
VIN not powered or charger disabled		-	-	1.0	
Power On Reset	V_{POR}				V
Rising V_{IN} threshold		3.5	3.6	3.7	
Falling V_{IN} threshold		2.4	2.5	2.6	
VIN-BAT Offset Voltage	V_{OS}				mV
Rising threshold		-	-	60	
Falling threshold		1.0	-	22	
Over-voltage Protection Rising Threshold	V_{OVP}	6.6	6.8	7.0	V
Over-voltage Protection Threshold Hysteresis	V_{OVPHYS}	-	200	-	mV
CHARGE CURRENT					
Constant Current Mode Charge Current Range ⁽⁷⁾	I_{CHG}	0.05	-	1.0	A
I_{CHG} Accuracy	I_{CHG}				I_{CHG}
For I_{CHG} between 300mA to 1000mA (tested at 450mA)		94%	100%	106%	
For I_{CHG} between 50mA to 300mA ⁽⁷⁾		90%	100%	110%	
Trickle-Mode Charge Current	I_{TRKL}	18%	20%	22%	I_{CHG}
End-of-Charge (EOC) Threshold	I_{EOC}				I_{CHG}
When $I_{CHG} > 300mA$ (tested at $I_{CHG} = 450mA$)		8.5%	10%	11.5%	
When $I_{CHG} < 300mA$ ⁽⁷⁾		8.0%	10%	12%	
ISET-Pin Voltage for I_{CHG} Reference	V_{ISET}	-	1.0	-	V

Notes

- Refer to the Power-on-Reset parameter for V_{IN} turn on and turn off values.
- Supply current does not include the current delivered to the battery through the BAT pin.
- Not tested. The accuracy is guaranteed by design.

Table 3. Static Electrical Characteristics (continued)

Characteristics noted under conditions $V_{IN} = 5V$, $-40^{\circ}C \leq T_A \leq 85^{\circ}C$, $C_{IN} = 1.0\mu F$, $C_{OUT} = 2.2\mu F$, $C_{DET} = 0.22\mu F$ (see [Figure 1](#)), unless otherwise noted. Typical values noted reflect the approximate parameter means at $V_{IN} = 5V$ and $T_A = 25^{\circ}C$ under nominal conditions, unless otherwise noted.

Characteristic	Symbol	Min	Typ	Max	Unit
----------------	--------	-----	-----	-----	------

CHARGE THRESHOLDS

Trickle Mode Rising Threshold Voltage	V_{TRKL}	2.6	2.7	2.8	V
Trickle Mode Threshold Voltage Hysteresis	$V_{TRKLHYS}$	40	100	150	mV
Recharge Threshold Voltage	V_{RECH}	4.075	4.100	4.125	V
Recharge Falling Threshold Voltage Hysteresis	$V_{RECHHYS}$	-	25	50	mV

LINEAR REGULATOR

Output Voltage $V_{IN} = 5.2V$, Output Current < 10mA, $I_{BAT} = 0mA$	V_{LR}	4.6	4.85	5.0	V
Dropout Voltage $V_{IN} = 4.7V$, Output Current = 10mA, $I_{BAT} = 0mA$	V_{DO}	-	90	150	mV
Output Current Limit	I_{REGLMT}	10	13	16	mA
Output Pull-down Resistance $2.0V < V_{IN} < V_{POR}$ or $V_{IN} > V_{OVP}$	R_{REGPD}	-	200	-	k Ω

LOGIC INPUT AND OUTPUT

\overline{EN} Input High Threshold Voltage	V_{IH}	1.5	-	-	V
\overline{EN} Input Low Threshold Voltage	V_{IL}	-	-	0.5	V
\overline{EN} Input Pull-down Current $V_{\overline{EN}} = 3V$	$I_{\overline{EN}}$	-	2.0	7.5	μA
\overline{PPR} and \overline{CHG} Sink Current when the Output is Low $V_{\overline{CHG}} = V_{\overline{PPR}} = 0.6V$	$I_{PCSINKL}$	9.0	15	-	mA
\overline{PPR} and \overline{CHG} Leakage Current When the Output is High-impedance $V_{\overline{CHG}} = V_{\overline{PPR}} = 5.0V$	$I_{PCLEAKH}$	-	-	1.0	μA

CHARGE CURRENT THERMAL FOLDBACK

Current Foldback Die Temperature Limit	T_{LIMIT}	100	120	140	$^{\circ}C$
--	-------------	-----	-----	-----	-------------

DYNAMIC ELECTRICAL CHARACTERISTICS**Table 4. Dynamic Electrical Characteristics**

Characteristics noted under conditions $V_{IN} = 5V$, $-40^{\circ}C \leq T_A \leq 85^{\circ}C$, $C_{IN} = 1\mu F$, $C_{OUT} = 2.2\mu F$, $C_{DET} = 0.22\mu F$ (see [Figure 1](#)), unless otherwise noted. Typical values noted reflect the approximate parameter means at $V_{IN} = 5V$ and $T_A = 25^{\circ}C$ under nominal conditions, unless otherwise noted.

Characteristic	Symbol	Min	Typ	Max	Unit
END OF CHARGE					
EOC Filter Time	t_{EOC}	6.0	8.0	12	ms
OSCILLATOR					
Oscillation Frequency	f_{OSC}	40.0	50.0	60.0	kHz

ELECTRICAL PERFORMANCE CURVES

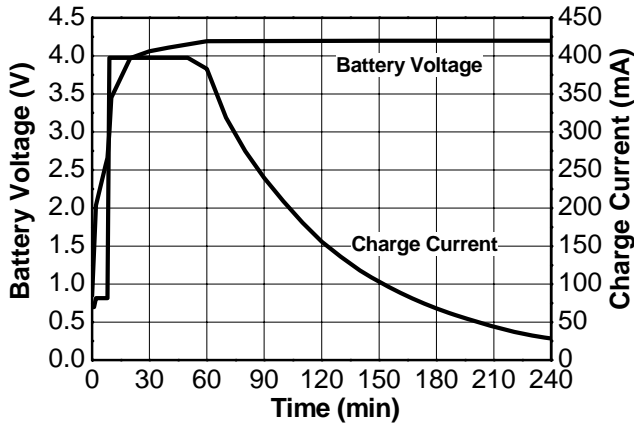

Figure 4. Complete Charge Cycle
 $V_{IN} = 5.0V$, $I_{CHG} = 400mA$, 740mAh Li-Ion Battery, $T_A = 25^\circ C$

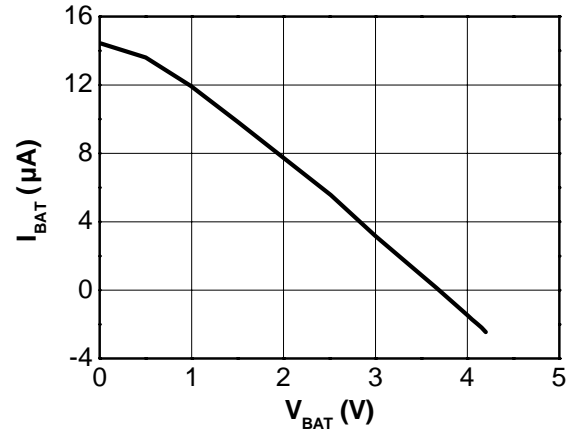

Figure 7. BAT Pin Current vs Battery Voltage in OVP
 $V_{IN} = 7.0V$, $T_A = 25^\circ C$

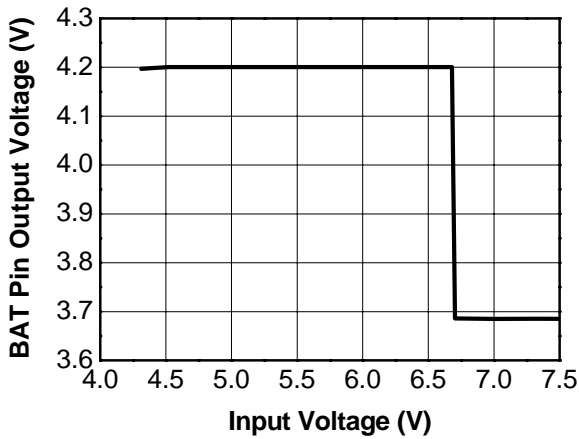

Figure 5. Charger Output Voltage vs V_{IN}
 $I_{BAT} = 0mA$, $T_A = 25^\circ C$

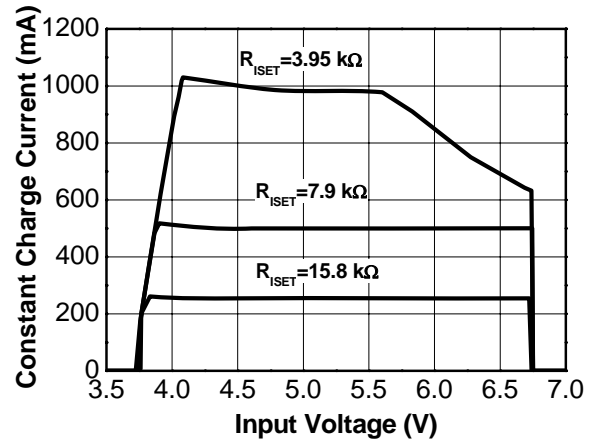

Figure 8. Constant Charge Current vs V_{IN}
 $V_{BAT} = 3.7V$, $T_A = 25^\circ C$

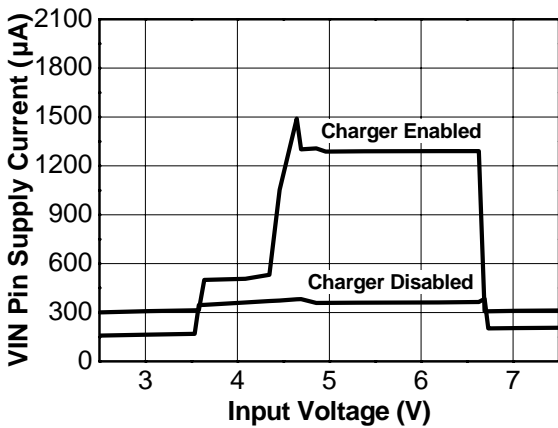

Figure 6. VIN Pin Supply Current vs V_{IN}
 $I_{BAT} = 0mA$, $T_A = 25^\circ C$

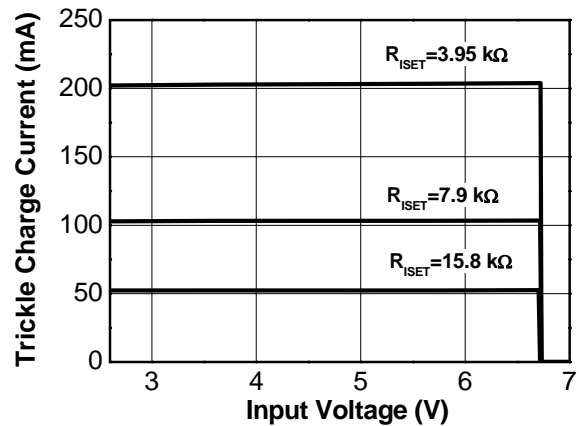

Figure 9. Trickle Charge Current vs V_{IN}
 $V_{BAT} = 2.0V$, $T_A = 25^\circ C$

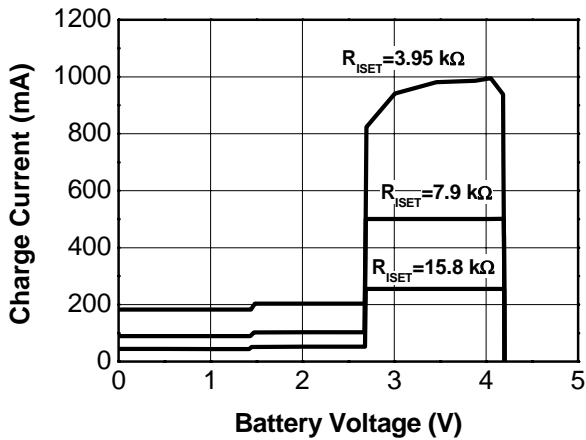

Figure 10. Charge Current vs Battery Voltage
 $V_{IN} = 5.0V$, $T_A = 25^\circ C$

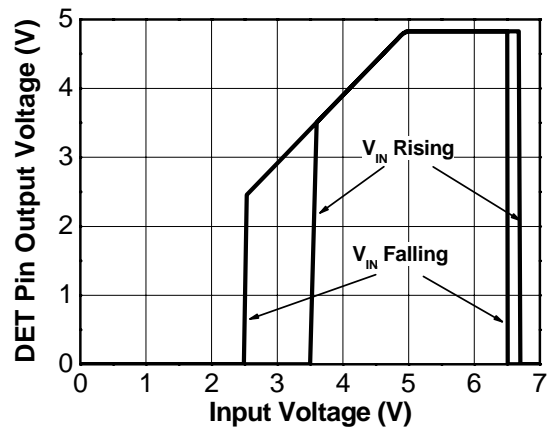

Figure 13. DET Pin Output Voltage vs Input Voltage
 $R_{DET} = 470\Omega$, $I_{BAT} = 0mA$, $T_A = 25^\circ C$

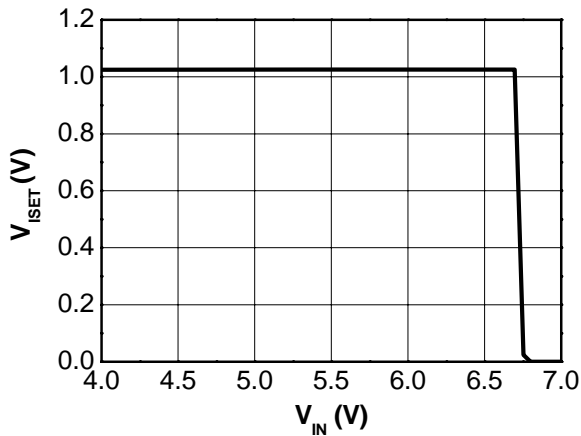

Figure 11. V_{ISET} vs V_{IN}
 $V_{BAT} = 3.7V$, $T_A = 25^\circ C$

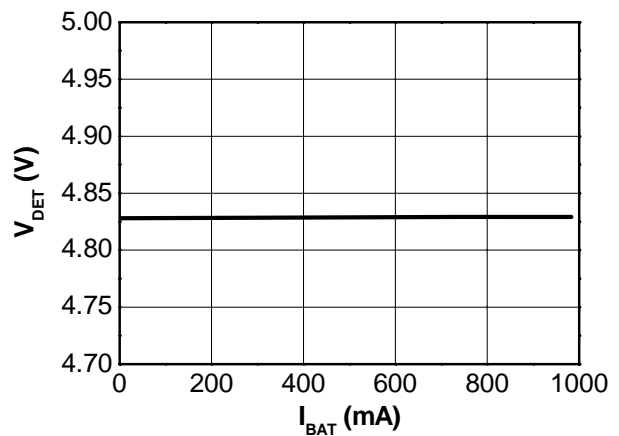

Figure 14. DET Pin Output Voltage vs Charge Current
 $V_{IN} = 5.2V$, $I_{DET} = 10mA$, $T_A = 25^\circ C$

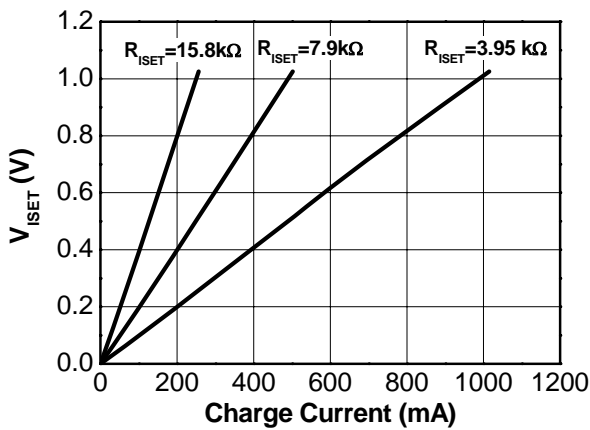

Figure 12. V_{ISET} vs Charge Current
 $V_{IN} = 5.0V$, $T_A = 25^\circ C$

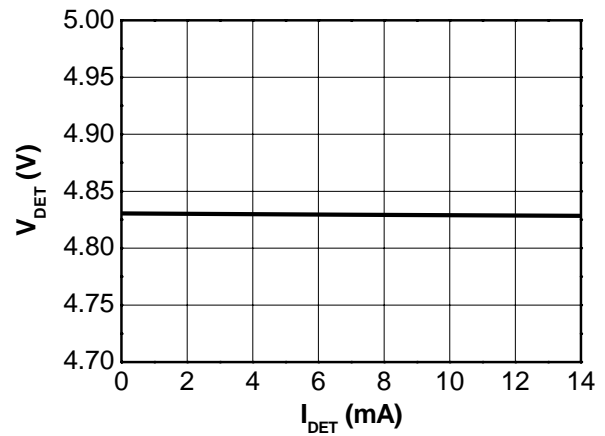

Figure 15. DET Pin Output Voltage vs Output Current
 $V_{IN} = 5.2V$, $I_{BAT} = 0mA$, $T_A = 25^\circ C$

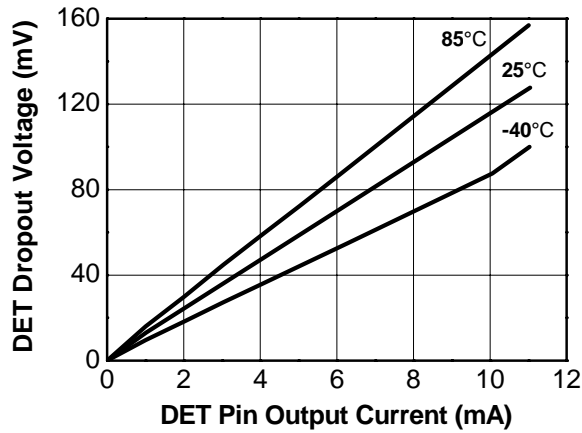

Figure 16. DET Dropout Voltage vs Output Current
 $V_{IN} = 4.7V, I_{BAT} = 0mA$

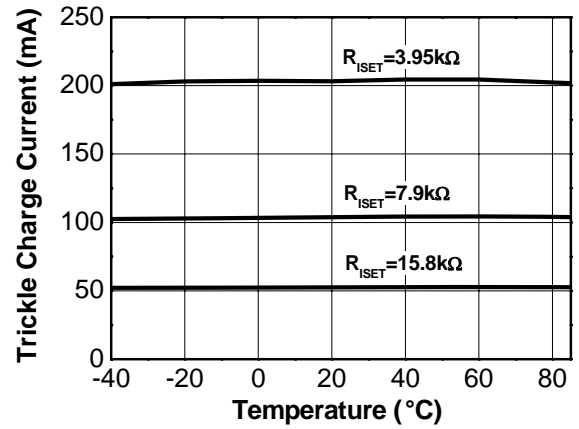

Figure 19. Trickle Charge Current vs Temperature
 $V_{IN} = 5.0V, V_{BAT} = 2.0V$

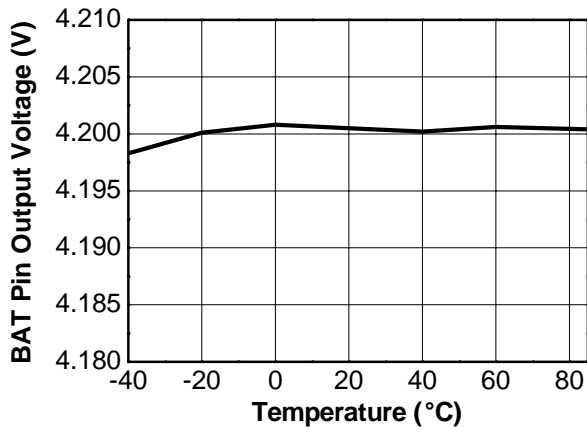

Figure 17. Charger Output Voltage vs Temperature
 $V_{IN} = 5.0V, I_{BAT} = 0mA$

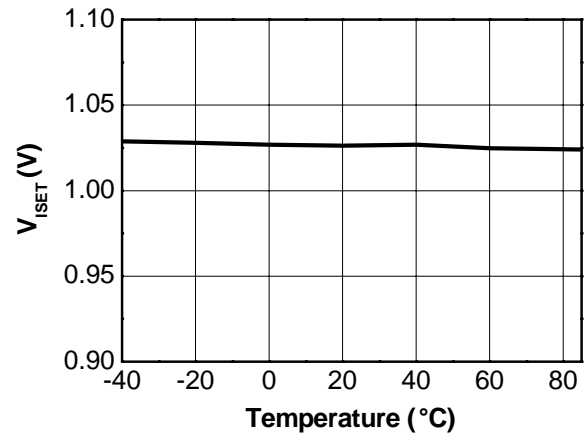

Figure 20. V_{ISET} vs Temperature
 $V_{IN} = 5.0V, V_{BAT} = 3.7V$

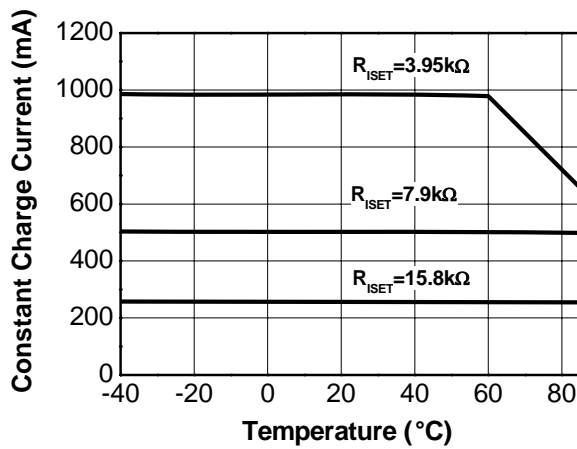

Figure 18. Constant Charge Current vs Temperature
 $V_{IN} = 5.0V, V_{BAT} = 3.7V$

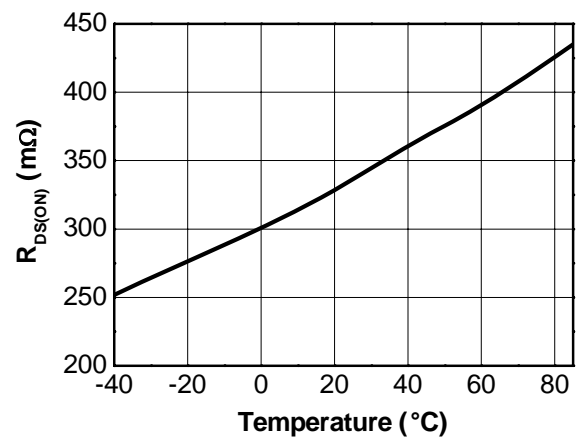

Figure 21. $R_{DS(ON)}$ vs Temperature
 $V_{BAT} = 4.0V, I_{CHG} = 500mA, I_{BAT} = 400mA$

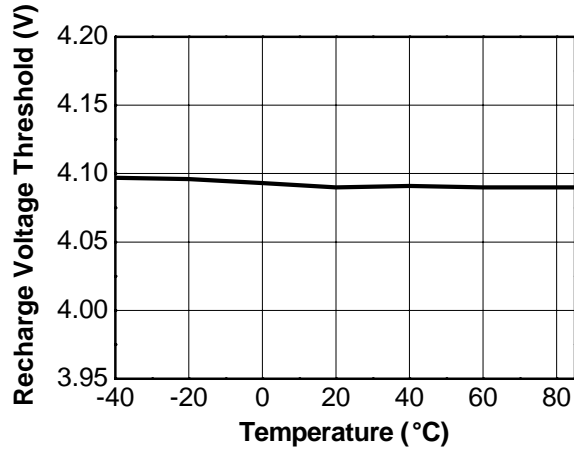

Figure 22. Recharge Voltage Threshold vs Temperature
 $R_{ISET} = 7.9k\Omega$, $V_{IN} = 5.0V$

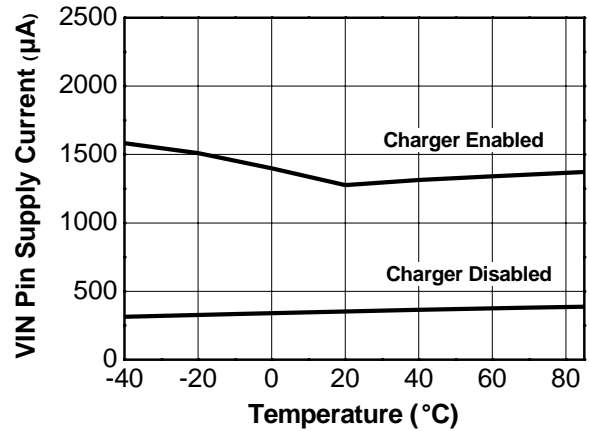

Figure 24. VIN Pin Supply Current vs Temperature
 $V_{IN} = 5.0V$

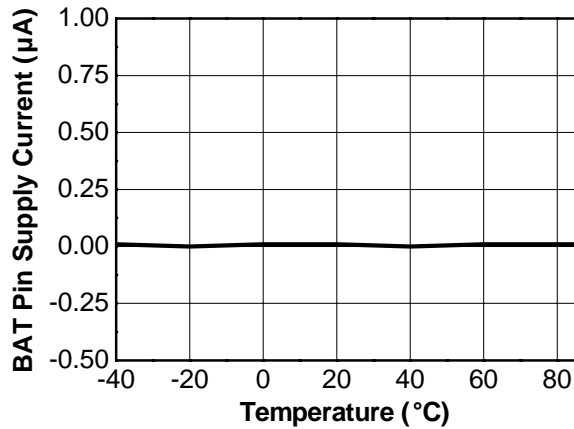

Figure 23. BAT Pin Supply Current vs Temperature
 $V_{BAT} = 4.2V$, VIN Pin Not Powered or Charger Disabled

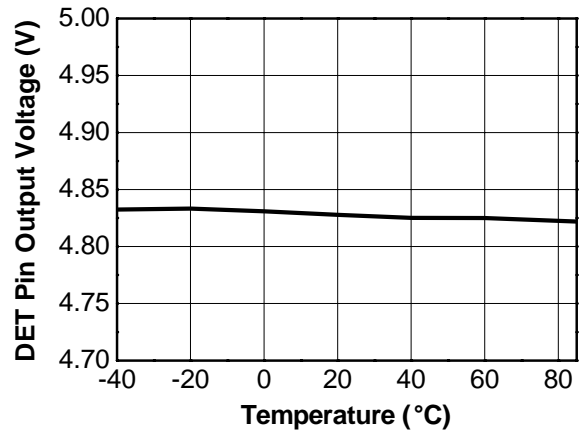

Figure 25. DET Pin Output Voltage vs Temperature
 $V_{IN} = 5.2V$, $I_{DET} = 10mA$, $I_{BAT} = 0mA$

FUNCTIONAL DESCRIPTION

INTRODUCTION

The 34675 is a fully-integrated Li-Ion and Li-Polymer battery charger, with a 4.85V/10mA linear regulator in a tiny package. It uses current, voltage, and temperature control loops to regulate the charge current. It has up to a 28V input voltage rating, which makes the handheld device safe even when connected to a wrong AC adapter. In addition, it provides a 4.85V/10mA linear regulator.

The 34675 requires only two external capacitors and one resistor to build a fully functional charger for space-limited applications such as cell phones, Bluetooth accessories and MP3 players. Its ultra high accuracy voltage ($\pm 0.7\%$) and temperature limited charging current, offer additional battery safety during charging.

The CC current can be programmed with an external resistor (R_{ISET}). The voltage across this resistor is

proportional to the charge current, so the system can monitor the charge current during the whole charge cycle. The EOC threshold is preset to 10% of the CC mode current. For a deeply discharged battery with a voltage lower than 2.7V, the 34675 charges the battery with a trickle-mode current, which is 20% of the CC mode current.

The linear regulator provides 4.85V with 10mA capability. The output is turned on when the input voltage is above the POR threshold, but lower than the OVP threshold. The Linear regulator is independent. It is not related to any signals of the charger, including the enable input pin.

Two indication outputs make it easy to report the input power status and the charge status to MCUs, or users via LEDs.

FUNCTIONAL PIN DESCRIPTION

INPUT SUPPLY (VIN)

The supply input. This pin should be bypassed to ground with a 1.0 μ F capacitor.

POWER PRESENT INDICATOR (\overline{PPR})

Open-drain logic output to indicate the status of the supply input voltage. The \overline{PPR} pin output is singularly determined by the input voltage. The output is pulled low if VIN is higher than VPOR. This pin is capable of sinking at least 9.0mA of current to drive an LED indicator.

CHARGE INDICATOR (\overline{CHG})

Open-drain logic output to indicate the charge status. The output is low when the 34675 is charging, until the EOC conditions are reached. This pin is capable of sinking at least 9.0mA of current to drive a LED indicator.

ENABLE (\overline{EN})

Active low enable logic Input. This pin is internally pulled to ground by a weak current source. When left floating, the charger is enabled. Pulling this pin to a high voltage externally disables the charger.

GROUND (GND)

Ground.

LINEAR REGULATOR OUTPUT (DET)

The linear regulator output. The output voltage is typically 4.85V. The output current capability is 10mA. Bypass this pin to ground with a ceramic capacitor between 0.1 μ F and 1.0 μ F.

CC MODE CURRENT SETTING AND CHARGE CURRENT MONITOR (ISET)

The CC mode current, I_{CHG} , is programmed by connecting a resistor, R_{ISET} , between this pin and ground. When charging in the CC mode, the voltage at this pin is 1.0V. The voltage reduces proportionally as the charge current reduces in the CV mode. During the whole charge cycle, the voltage at this pin can be used to monitor the charge current, using the following equation:

$$I_{BAT} = \frac{V_{ISET}}{1.0V} \cdot I_{CHG}$$

where I_{BAT} is the actual charge current, I_{CHG} is the programmed CC mode current, and V_{ISET} is the voltage of the ISET pin during the whole charge cycle.

CHARGER OUTPUT (BAT)

Charger output pin. Connect this pin to the battery being charged. Bypass to ground with a 2.2 μ F or higher capacitor.

EXPOSED PAD (EPAD)

Exposed pad. This must be soldered to the large ground plane on the PCB to enhance the thermal conductivity. The pad must be connected to GND electrically.

FUNCTIONAL INTERNAL BLOCK DESCRIPTION

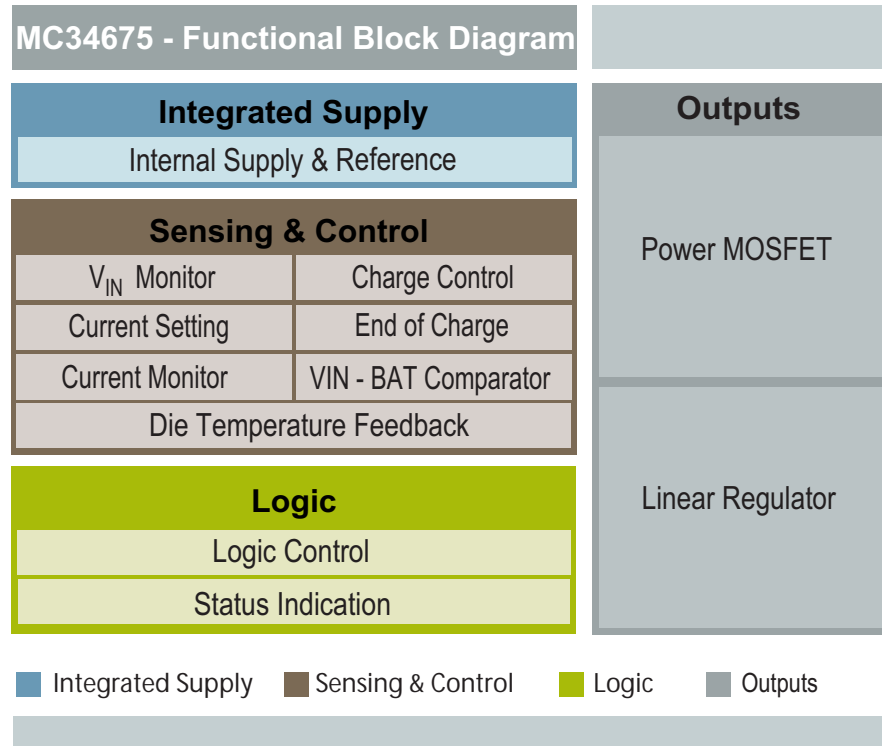

Figure 26. 34675 Functional Internal Block Diagram

INTEGRATED SUPPLY

Internal Supply and Reference

This block steps down the high input voltage to a lower voltage which powers all the internal blocks. In addition, this block generates the reference voltage for the charge-control block.

SENSING & CONTROL

VIN (Input Voltage) Monitor

The input voltage monitor block monitors the input voltage for two thresholds, power-on-reset (POR) and over-voltage protection (OVP). If the input is lower than the POR or higher than the OVP threshold, this block outputs a logic signal to disable the charger and the linear regulator.

Current Setting & Monitor

This block sets the charge current in the constant-current mode, and monitors the actual charge current during the whole charge cycle.

Charge Control

The charge control block controls the gate voltage of the power MOSFET to regulate the charge current, the battery voltage, or the die temperature. It can also completely turn off the power MOSFET, to stop the current flow between the input and the battery. Additionally, monitoring of the charge current and the charger output voltage determines the trickle-charge mode and the recharge cycle.

EOC (End of Charge)

The EOC block monitors the charge current and the battery voltage for the EOC conditions. Once the EOC conditions are reached, this block outputs a logic signal to indicate the end of the charge.

VIN-BAT Comparator

The VIN-BAT comparator monitors the voltage difference between the input voltage and the battery voltage. The input voltage has to be higher than the battery voltage for the charger to be enabled. If the input voltage falls below the battery voltage, this block outputs a signal to disable the charger to prevent the leakage current from the battery to the input.

Die-Temperature feedback

The die temperature feedback block monitors the die temperature. Once the die temperature reaches the threshold temperature, this charge control block can reduce the charge current to prevent further die temperature rise.

LOGIC

Logic Control and Status Indication

The logic control block determines the on and off of the charger and indicates the charger status. It takes the signals from the input voltage monitor, VIN-BAT comparator, EOC, and the external enable signal, and determines the on and off states as well as the charge status indication outputs of the charger (CHG and PPR).

OUTPUTS

Power MOSFET

The power MOSFET passes the charging current from the input to the output.

Linear Regulator

The linear regulator outputs a regulated 4.85V from the input voltage with 10mA current capability. If the Input Voltage Monitor detects that the input voltage is lower than the POR or higher than the OVP threshold, the linear regulator is disabled. No other signal can control the linear regulator.

FUNCTIONAL DEVICE OPERATION

OPERATIONAL MODES

CHARGE CYCLE

The 34675 uses the standard charge profile with trickle, constant-current (CC), and constant-voltage (CV) charge modes, as shown in [Figure 27](#). Both the CC and the CV charge modes are also called fast-charge mode. When the input voltage rises above an internal power-on-reset threshold, the $\overline{\text{PPR}}$ pin outputs a low voltage to indicate the power-supply presence. The charger starts with the trickle-charge mode until the battery voltage is above 2.7V. The CHG pin outputs logic low voltage at the beginning of the trickle-charge mode. If the battery voltage is unable to rise due to a battery failure, charging will remain in the trickle-charge mode. When the battery voltage reaches the 2.7V threshold, the 34675 softly changes to the CC mode. The soft transition minimizes the input-voltage drop and reduces the requirement of the input decoupling capacitance. When the battery voltage reaches 4.2V, the 34675 enters the CV mode and regulates the output voltage at 4.2V. The charge current decreases gradually in the CV mode. When the current drops to the EOC current threshold, the 34675 outputs logic high level at the CHG pin to indicate that the charging is completed.

After the charge cycle is completed, the 34675 continues to regulate and monitor the output to 4.2V. If a load is connected in parallel with the battery, the 34675 will ensure that the charger continues to supply the charge current, even if the charge cycle is completed. If the load current exceeds the pre-programmed CC mode current, the battery will supply the additional current to the load, thereby reducing the battery voltage. Once the battery voltage drops below the recharge voltage, the 34675 returns to the fast charge mode and indicates a logic low at the CHG pin.

When one of the following three conditions happens, the 34675 stops charging and enters disable mode.

1. $V_{\text{IN}} > V_{\text{OVP}}$
2. $V_{\text{IN}} - V_{\text{BAT}} < V_{\text{OS}}$
3. $\overline{\text{EN}}$ pin is high

where V_{OS} is the offset voltage for the comparator that monitors the input and the battery voltages

[Figure 29](#) shows the complete charge cycle state diagram.

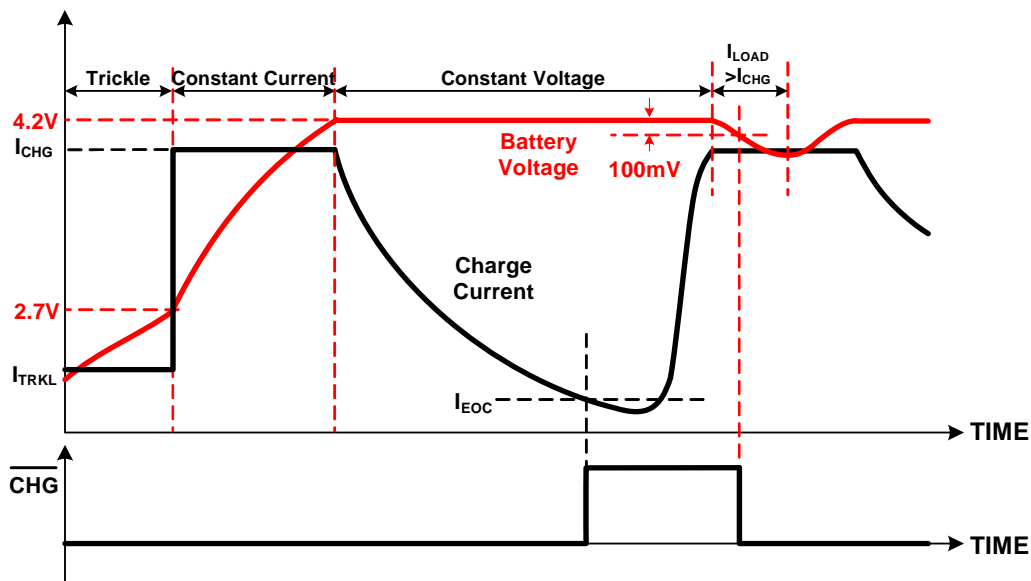

Figure 27. Charge Profile

CHARGE CURRENT SETTING

An external resistor between the ISET pin and ground sets the CC mode current with the following equation:

$$I_{\text{CHG}} = \frac{4000}{R_{\text{ISET}}}$$

where R_{ISET} is the resistor between the ISET pin and ground in Ω . I_{CHG} is in Amps. In addition, the current out of the ISET pin is proportional to the charge current. The system may measure the ISET pin voltage to monitor the actual charge current during the whole charging cycle, using the following equation:

$$I_{\text{BAT}} = \frac{V_{\text{ISET}}}{1.0\text{V}} \cdot I_{\text{CHG}}$$

CHARGE CURRENT LIMITATION

The charge current is limited by multiple factors.

When the voltage difference between the input and the battery ($V_{\text{IN}} - V_{\text{BAT}}$) is low, $(V_{\text{IN}} - V_{\text{BAT}}) / R_{\text{DS(ON)}}$, where $R_{\text{DS(ON)}}$ is the on resistance of the power MOSFET, may be less than the programmed CC mode current I_{CHG} . In this case, the charge current is limited by $(V_{\text{IN}} - V_{\text{BAT}}) / R_{\text{DS(ON)}}$.

When the voltage difference between the input and the battery is too high, the large power dissipation may lead to the charge current thermal foldback operation, due to the die temperature regulation. The charge current is reduced to prevent further temperature rise (See [Charge Current Thermal Foldback](#) section for more information).

DC INPUT VOLTAGE

The 34675 accepts up to a 28V DC input. When all of the following conditions are satisfied, the input is in a power-good range for the charger to start charging. The conditions include:

1. $V_{\text{IN}} > V_{\text{POR}}$
2. $V_{\text{IN}} - V_{\text{BAT}} > V_{\text{OS}}$
3. $V_{\text{IN}} < V_{\text{OVP}}$

where V_{OS} is the offset voltage for the comparator that monitors the input and the battery voltages. The V_{OS} is for preventing the reverse leakage current from the battery when the external power supply is off. V_{OVP} is the over-voltage protection threshold. When the DC input voltage is above the over-voltage protection threshold, the charger is disabled internally. The 28V input voltage rating eliminates the need of any additional input over-voltage protection circuitry.

CHARGE-ENABLE INPUT

The charge-enable input, $\overline{\text{EN}}$, has a weak internal pull-down current. Driving it to a low voltage, leaving it float, or shorting it to ground, will enable the charger if the input voltage is in the power-good range. Whenever the $\overline{\text{EN}}$ pin is driven to a high voltage, the charger is disabled. When the charger is disabled, the BAT pin does not output voltage and current, the leakage current into the BAT pin is less than 1.0 μA , the output of the $\overline{\text{CHG}}$ pin is high, and the voltage at the ISET pin is zero. If the input voltage is in the power-good range when the charger is disabled, the output of the PPR is still low to indicate the input voltage status and the DET pin outputs voltage as well.

INPUT POWER PRESENCE INDICATOR

When V_{IN} is applied and the voltage is above the power-on-reset voltage threshold (V_{POR}), the PPR pin outputs a low voltage to indicate the input-power presence. The PPR output is only controlled by the input voltage. All other functions, such as the $\overline{\text{EN}}$ pin, the over-voltage protection, and the VIN-BAT comparator, do not affect the PPR output. The PPR pin is capable of sinking at least 9.0mA of current when outputting a low voltage to drive an external LED.

CHARGE STATUS INDICATORS

The 34675 has one charge-status indicator, $\overline{\text{CHG}}$. $\overline{\text{CHG}}$ outputs a low voltage when the charger is enabled and the charging is in progress. When the charge cycle completes, $\overline{\text{CHG}}$ outputs high-impedance. If the charger is disabled or the input voltage is out of the power-good range, the $\overline{\text{CHG}}$ pin outputs a high-impedance as well. The $\overline{\text{CHG}}$ pin has at least 9.0mA current-sinking capability to drive an external LED, the same as the PPR pin.

CHARGE CURRENT THERMAL FOLDBACK

An internal thermal feedback loop begins to reduce the charge current, when the die temperature reaches 120°C, to prevent further temperature rise. This feature protects the 34675 from over-temperature failure, and allows the user to push the limits of the power-handling capability of a given circuit board, without the risk of damaging the 34675. The charge current can be programmed according to the typical (not the worst case) ambient temperature, with the assurance that the charger will automatically reduce the current in worst case conditions.

LINEAR REGULATOR

The linear regulator provides a 4.85V output with 10mA current capability. The output is turned on when the input voltage is above the POR threshold but lower than the OVP threshold. The output is independent of any other signals in the charger, such as the enable ($\overline{\text{EN}}$) input.

When the input reaches the rising POR threshold, the DET output starts to output a voltage, but is in the dropout mode. The output voltage is determined by the dropout voltage. As the input voltage rises above the regulation voltage, the output is regulated at 4.85V. When the input voltage further rises above the OVP rising threshold, the linear regulator is turned off, and the output voltage drops to zero with an internal 200k Ω pull-down resistor. The output voltage resumes to 4.85V when the input voltage falls below the OVP falling threshold. The output voltage versus the input voltage is shown in [Figure 28](#), where the V_{PORR} and V_{PORF} are the POR rising and falling threshold. The V_{OVP} and V_{OVPF} are the OVP rising and falling threshold. An output decoupling capacitor of 0.1 μF to 1.0 μF is required between the DET pin and ground for the stability of the linear regulator.

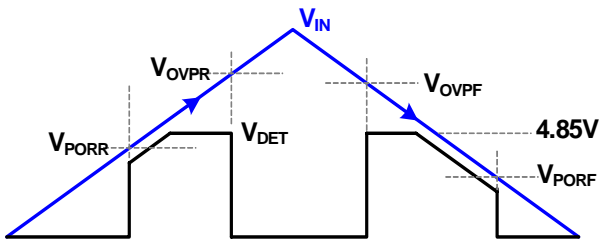

Figure 28. DET Pin Output Voltage vs Input Voltage

CHARGE STATE DIAGRAM

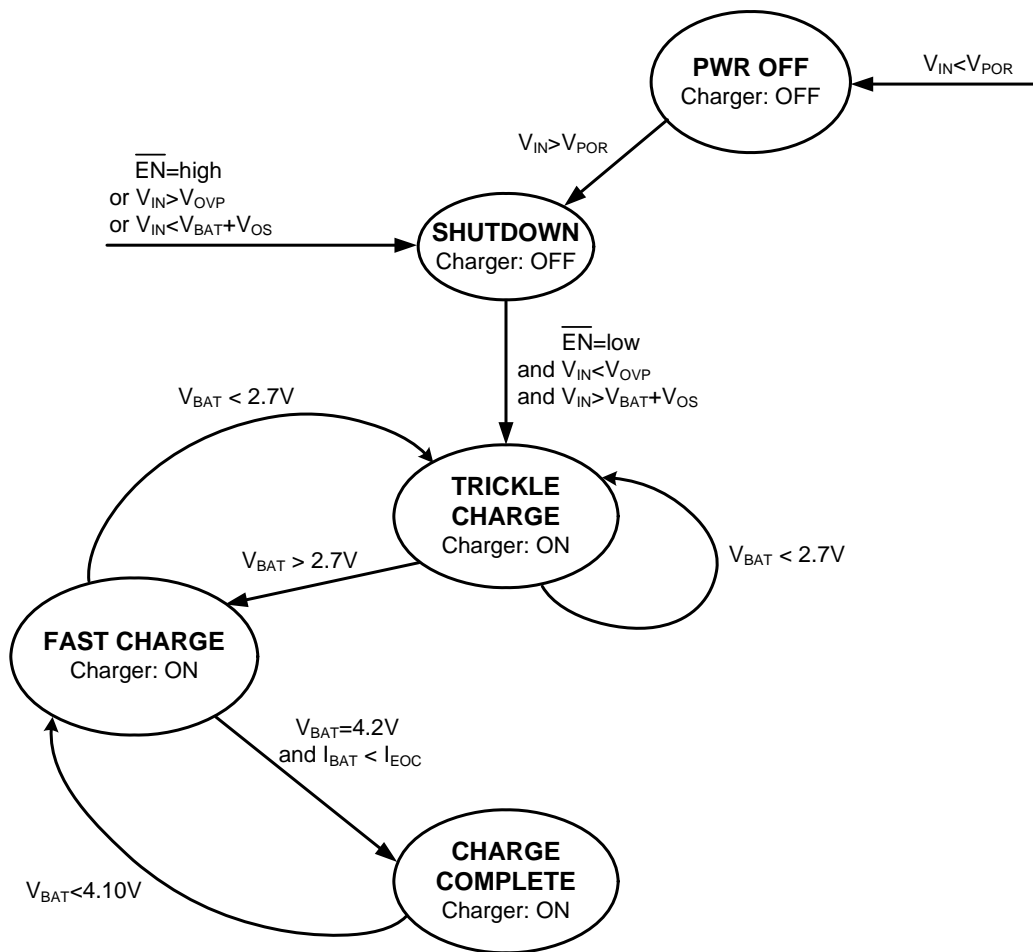

Figure 29. Charge Cycle State Diagram

TYPICAL APPLICATIONS

APPLICATION INFORMATION

INPUT CAPACITOR

The input capacitor is used to reduce the input voltage transient, which may cause instability when the input voltage is near $V_{BAT} + V_{OS}$. A 1.0 μ F, X5R, 16V rated ceramic capacitor is recommended for most applications.

OUTPUT CAPACITOR

For stable operation, an X5R ceramic capacitor with a minimum 2.2 μ F nominal value is recommended at the charger output. Depending on the load transient current, a larger capacitance may be required.

The linear regulator is designed to be stable with a ceramic capacitor of 0.1 μ F through 1.0 μ F. An X5R ceramic capacitor of 0.22 μ F is recommended for the application.

CC MODE CURRENT SETTING

The CC mode current can be programmed by the external resistor, R_{ISET} . A 1% accuracy resistor is recommended to guarantee 6% current accuracy.

DROPOUT VOLTAGE

If the DC input voltage is too low, it may not maintain the programmed charge current due to the voltage dropout over

the power MOSFET. The worst case of the $R_{DS(ON)}$ is 475m Ω . The input voltage should be at least higher than $V_{BAT} + I_{CHG} \times 475m\Omega$, to guarantee the programmed CC mode current.

USE DET AS POWER PRESENCE INTERRUPT

Some cell phone designs require an active-high power presence indication signal, to turn on an originally-off phone, when an ac/dc adapter is plugged in. The \overline{DET} output can be used for such a purpose, instead of the PPR pin.

THERMAL CONSIDERATIONS

The 34675 is available in a tiny 2x3 thermally-enhanced UDFN package. A careful thermal design must be considered. The exposed pad needs to be well soldered to a large copper ground plane on the component layer. If the component layer is space limited and does not allow for a large copper plane, the thermal pad must be connected to other ground layers through a via array. This allows the 34675 to charge the battery with the maximum current, while minimizing the die temperature.

TYPICAL APPLICATIONS

CHARGER IN THE HANDHELD SYSTEM

When the charger is used in handheld systems with MCU control, the 34675 uses \overline{PPR} to report the DC input status to the MCU. After the MCU pulls the EN pin to a low logic level to start charging, the 34675 reports the charge status through

the \overline{CHG} pin to the MCU. The MCU can also monitor the charge current by measuring the voltage at the ISET pin. The linear regulator powers subsystems, such as a USB transceiver, that require a voltage higher than 4.5V. [Figure 30](#) is the typical application circuit.

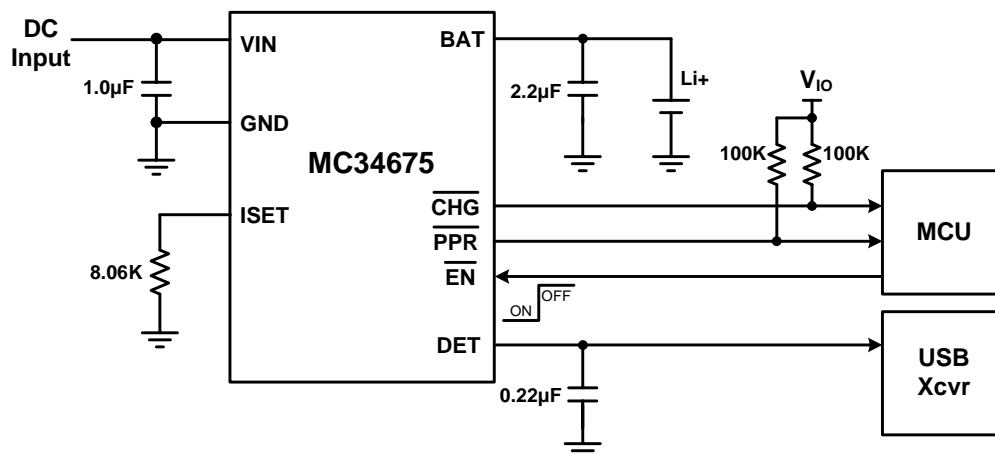
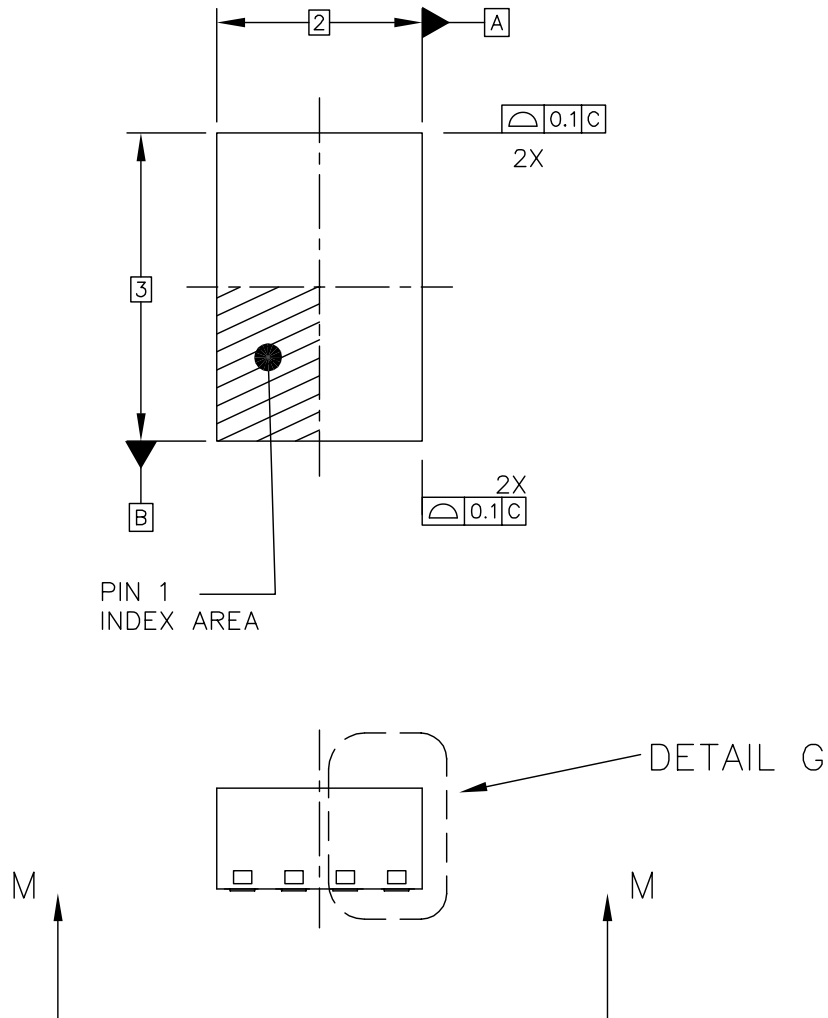

Figure 30. Li+ Battery Charger in Handheld System

PACKAGING

PACKAGE DIMENSIONS

For the most current package revision, visit www.freescale.com and perform a keyword search using the "98A" listed below.



© FREESCALE SEMICONDUCTOR, INC. ALL RIGHTS RESERVED.	MECHANICAL OUTLINE	PRINT VERSION NOT TO SCALE	
TITLE: THERMALLY ENHANCED PLASTIC ULTRA THIN DUAL FLAT NO LEAD PACKAGE (UDFN) 8 TERMINAL, 0.5 PITCH (2 X 3 X 0.65)	DOCUMENT NO: 98ASA10774D	REV: 0	
	CASE NUMBER: 1924-01	14 MAY 2007	
	STANDARD: NON-JEDEC		

EP SUFFIX
8-PIN
98ASA10774D
REVISION 0

PACKAGING DIMENSIONS (CONTINUED)

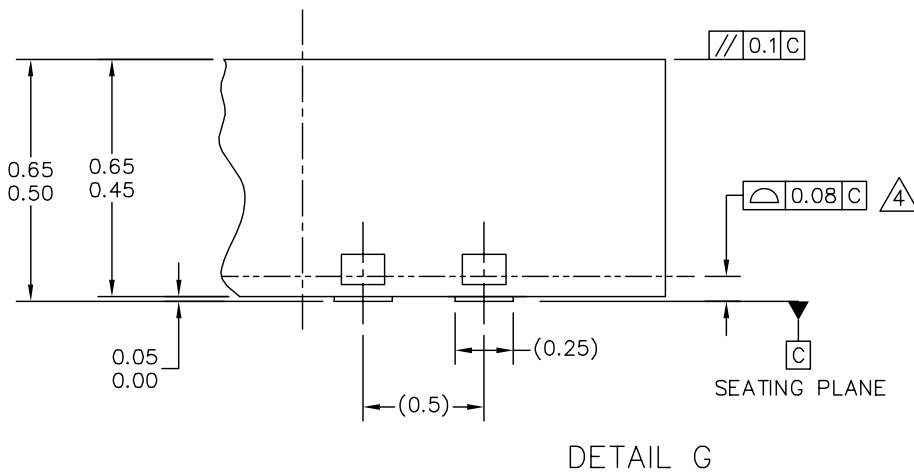
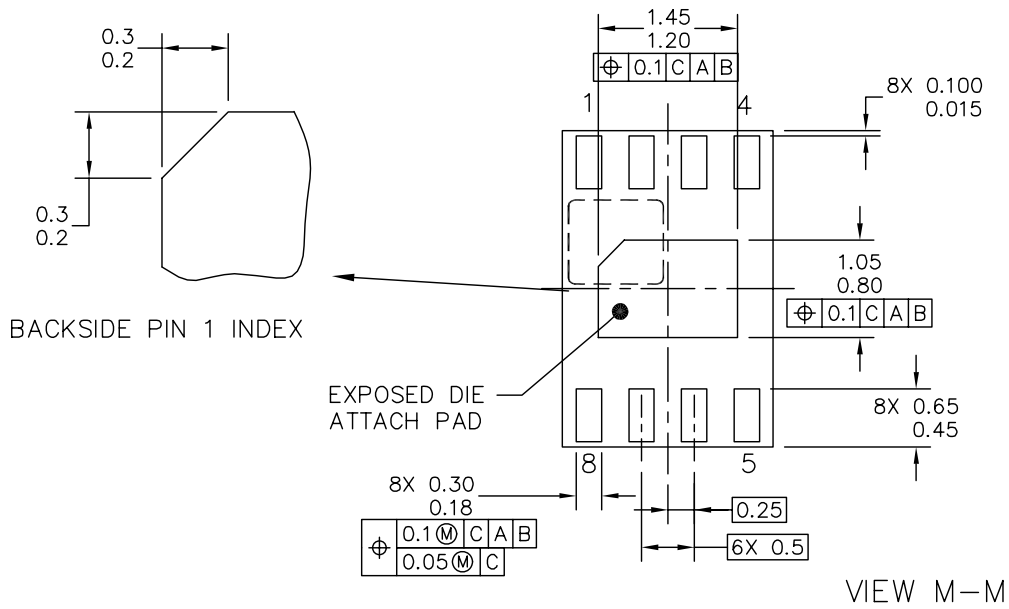

© FREESCALE SEMICONDUCTOR, INC. ALL RIGHTS RESERVED.	MECHANICAL OUTLINE	PRINT VERSION NOT TO SCALE	
TITLE: THERMALLY ENHANCED PLASTIC ULTRA THIN DUAL FLAT NO LEAD PACKAGE (UDFN) 8 TERMINAL, 0.5 PITCH (2 X 3 X 0.65)	DOCUMENT NO: 98ASA10774D	REV: 0	
	CASE NUMBER: 1924-01	14 MAY 2007	
	STANDARD: NON-JEDEC		

EP SUFFIX
 8-PIN
 98ASA10774D
 REVISION 0

PACKAGING DIMENSIONS (CONTINUED)

NOTES:

1. ALL DIMENSIONS ARE IN MILLIMETERS.
2. INTERPRET DIMENSIONS AND TOLERANCES PER ASME Y14.5M-1994.
3. THE COMPLETE JEDEC DESIGNATOR FOR THIS PACKAGE IS: HF-PDSO-N.
4.  COPLANARITY APPLIES TO LEADS AND DIE ATTACH PAD.
5. MIN. METAL GAP SHOULD BE 0.2 MM EXCEPT GAP BETWEEN LEADS TO EXPOSED DIE ATTACH PAD IS 0.15 MM.

© FREESCALE SEMICONDUCTOR, INC. ALL RIGHTS RESERVED.	MECHANICAL OUTLINE	PRINT VERSION NOT TO SCALE	
TITLE:THERMALLY ENHANCED PLASTIC ULTRA THIN DUAL FLAT NO LEAD PACKAGE (UDFN) 8 TERMINAL, 0.5 PITCH (2 X 3 X 0.65)	DOCUMENT NO: 98ASA10774D	REV: 0	
	CASE NUMBER: 1924-01	14 MAY 2007	
	STANDARD: NON-JEDEC		

EP SUFFIX
 8-PIN
 98ASA10774D
 REVISION 0

REVISION HISTORY

REVISION	DATE	DESCRIPTION OF CHANGES
1.0	4/2008	<ul style="list-style-type: none">Initial Release
2.0	4/2008	<ul style="list-style-type: none">Added Tape & Reel positioning drawing
3.0	4/2008	<ul style="list-style-type: none">Deleted Tape & Reel positioning drawing

How to Reach Us:

Home Page:

www.freescale.com

Web Support:

<http://www.freescale.com/support>

USA/Europe or Locations Not Listed:

Freescale Semiconductor, Inc.
Technical Information Center, EL516
2100 East Elliot Road
Tempe, Arizona 85284
+1-800-521-6274 or +1-480-768-2130
www.freescale.com/support

Europe, Middle East, and Africa:

Freescale Halbleiter Deutschland GmbH
Technical Information Center
Schatzbogen 7
81829 Muenchen, Germany
+44 1296 380 456 (English)
+46 8 52200080 (English)
+49 89 92103 559 (German)
+33 1 69 35 48 48 (French)
www.freescale.com/support

Japan:

Freescale Semiconductor Japan Ltd.
Headquarters
ARCO Tower 15F
1-8-1, Shimo-Meguro, Meguro-ku,
Tokyo 153-0064
Japan
0120 191014 or +81 3 5437 9125
support.japan@freescale.com

Asia/Pacific:

Freescale Semiconductor Hong Kong Ltd.
Technical Information Center
2 Dai King Street
Tai Po Industrial Estate
Tai Po, N.T., Hong Kong
+800 2666 8080
support.asia@freescale.com

For Literature Requests Only:

Freescale Semiconductor Literature Distribution Center
P.O. Box 5405
Denver, Colorado 80217
1-800-441-2447 or 303-675-2140
Fax: 303-675-2150
LDCForFreescaleSemiconductor@hibbertgroup.com

Information in this document is provided solely to enable system and software implementers to use Freescale Semiconductor products. There are no express or implied copyright licenses granted hereunder to design or fabricate any integrated circuits or integrated circuits based on the information in this document.

Freescale Semiconductor reserves the right to make changes without further notice to any products herein. Freescale Semiconductor makes no warranty, representation or guarantee regarding the suitability of its products for any particular purpose, nor does Freescale Semiconductor assume any liability arising out of the application or use of any product or circuit, and specifically disclaims any and all liability, including without limitation consequential or incidental damages. "Typical" parameters that may be provided in Freescale Semiconductor data sheets and/or specifications can and do vary in different applications and actual performance may vary over time. All operating parameters, including "Typicals", must be validated for each customer application by customer's technical experts. Freescale Semiconductor does not convey any license under its patent rights nor the rights of others. Freescale Semiconductor products are not designed, intended, or authorized for use as components in systems intended for surgical implant into the body, or other applications intended to support or sustain life, or for any other application in which the failure of the Freescale Semiconductor product could create a situation where personal injury or death may occur. Should Buyer purchase or use Freescale Semiconductor products for any such unintended or unauthorized application, Buyer shall indemnify and hold Freescale Semiconductor and its officers, employees, subsidiaries, affiliates, and distributors harmless against all claims, costs, damages, and expenses, and reasonable attorney fees arising out of, directly or indirectly, any claim of personal injury or death associated with such unintended or unauthorized use, even if such claim alleges that Freescale Semiconductor was negligent regarding the design or manufacture of the part.

Freescale™ and the Freescale logo are trademarks of Freescale Semiconductor, Inc. All other product or service names are the property of their respective owners.

© Freescale Semiconductor, Inc., 2008. All rights reserved.