



3.0 MHz, 300 mA, DC-to-DC Boost Converter

PCA9412

Last Updated: Apr 9, 2022

The PCA9412 and PCA9412A are highly efficient 3.0 MHz, 300 mA, step-up DC-to-DC converters. They convert input voltages from 2.5 V to 5.25 V to a fixed output voltage of 5.4 V.

These devices are optimized for battery-powered applications. High efficiency of up to 94 % enables an extended battery life in all portable designs. Step-up operation at a switching frequency of 3 MHz allows using 1 µH inductor or smaller.

PCA9412 Block Diagram Block Diagram

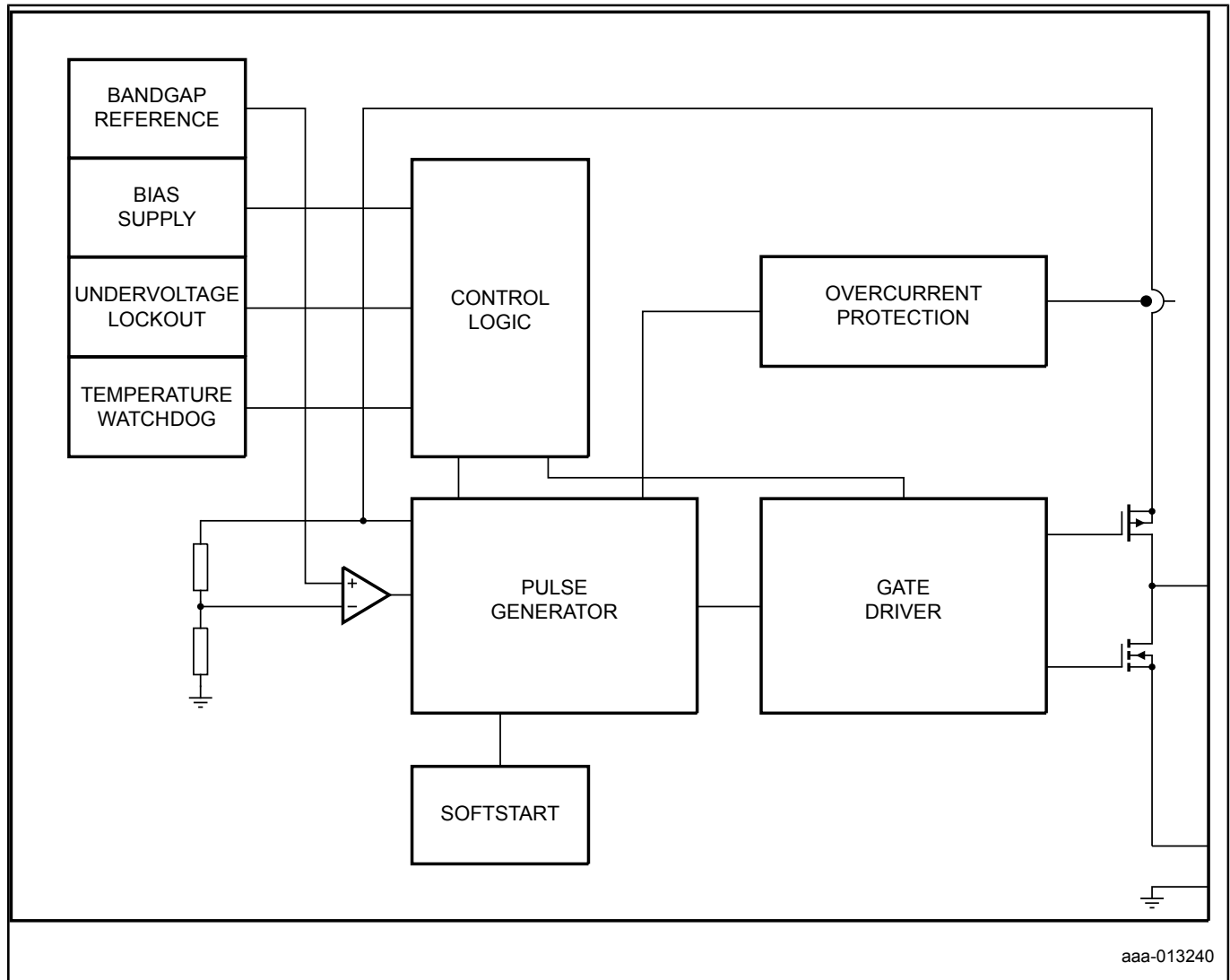

View additional information for [3.0 MHz, 300 mA, DC-to-DC Boost Converter](#).

Note: The information on this document is subject to change without notice.

www.nxp.com

NXP and the NXP logo are trademarks of NXP B.V. All other product or service names are the property of their respective owners. The related technology may be protected by any or all of patents, copyrights, designs and trade secrets. All rights reserved. © 2024 NXP B.V.