



UM11578

PCF85063AT-ARD evaluation board

Rev. 1 — 19 February 2021

User manual

Document information

Information	Content
Keywords	PCF85063AT, I2C-bus, RTC, Real Time Clock, Arduino port, EVK
Abstract	The PCF85063AT-ARD evaluation board is a daughter card equipped with Arduino port, designated for easy test and design of PCF85063A IC, tiny real-time clock/calendar with alarm function, controlled through Fm I2C 2-wire bus. The board is fully compliant with MIMXRT1050-EVK, LPC55S69-EVK and 8MMINILPD4-EVK, including GUI software control. The board can be attached to any device equipped with Arduino port.



1 Revision history

Revision history

Rev	Date	Description
v.1	20210219	Initial version

Important Notice

NXP provides the enclosed product(s) under the following conditions:

This evaluation kit is intended for use of ENGINEERING DEVELOPMENT OR EVALUATION PURPOSES ONLY. It is provided as a sample IC pre-soldered to a printed circuit board to make it easier to access inputs, outputs, and supply terminals. This evaluation board may be used with any development system or other source of I/O signals by simply connecting it to the host MCU or computer board via off-the-shelf cables. This evaluation board is not a Reference Design and is not intended to represent a final design recommendation for any particular application. Final device in an application will be heavily dependent on proper printed circuit board layout and heat sinking design as well as attention to supply filtering, transient suppression, and I/O signal quality.

The goods provided may not be complete in terms of required design, marketing, and or manufacturing related protective considerations, including product safety measures typically found in the end product incorporating the goods. Due to the open construction of the product, it is the user's responsibility to take any and all appropriate precautions with regard to electrostatic discharge. In order to minimize risks associated with the customers applications, adequate design and operating safeguards must be provided by the customer to minimize inherent or procedural hazards. For any safety concerns, contact NXP sales and technical support services.

Should this evaluation kit not meet the specifications indicated in the kit, it may be returned within 30 days from the date of delivery and will be replaced by a new kit.

NXP reserves the right to make changes without further notice to any products herein. NXP makes no warranty, representation or guarantee regarding the suitability of its products for any particular purpose, nor does NXP assume any liability arising out of the application or use of any product or circuit, and specifically disclaims any and all liability, including without limitation consequential or incidental damages. Typical parameters can and do vary in different applications and actual performance may vary over time. All operating parameters, including Typical, must be validated for each customer application by customer's technical experts.

NXP does not convey any license under its patent rights nor the rights of others. NXP products are not designed, intended, or authorized for use as components in systems intended for surgical implant into the body, or other applications intended to support or sustain life, or for any other application in which the failure of the NXP product could create a situation where personal injury or death may occur.

Should the Buyer purchase or use NXP products for any such unintended or unauthorized application, the Buyer shall indemnify and hold NXP and its officers, employees, subsidiaries, affiliates, and distributors harmless against all claims, costs, damages, and expenses, and reasonable attorney fees arising out of, directly or indirectly, any claim of personal injury or death associated with such unintended or unauthorized use, even if such claim alleges NXP was negligent regarding the design or manufacture of the part.

2 Introduction

This document describes the PCF85063AT-ARD demo board. The evaluation board is built around the PCF85063AT IC and works as a daughter card. The card can be connected through an Arduino port to various Arduino compatible (including original Arduino Uno R3) boards. The board is intended to test and measure the characteristics of the PCF85063A tiny real-time clock/calendar with alarm function and I2C-bus, supported by NXP Semiconductors.

The RTC communicates with the controller / microprocessor through a bidirectional Fm I2C-bus. Among the device under test (DUT) IC, the board is equipped with an Arduino port and the necessary components for easy testing, shortening the time to make measurements and check operation of the PCF85063AT IC.

Additionally, the daughter board has software support and a graphical user interface (Windows platform) for the following NXP evaluation boards: MIMXRT1050-EVK board, LPC55S69-EVK development board, and 8MMINILPD4-EVK board.

3 Finding kit resources and information on the NXP web site

NXP Semiconductors provides online resources for this evaluation board and its supported device(s) on <http://www.nxp.com>.

The information page for PCF85063AT-ARD evaluation board is at <http://www.nxp.com/PCF85063AT-ARD>. The information page provides overview information, documentation, software and tools, parametrics, ordering information and a **Getting Started** tab. The **Getting Started** tab provides quick-reference information applicable to using the PCF85063AT-ARD evaluation board, including the downloadable assets referenced in this document.

3.1 Collaborate in the NXP community

The NXP community is for sharing ideas and tips, ask and answer technical questions, and receive input on just about any embedded design topic.

The NXP community is at <http://community.nxp.com>.

4 Getting ready

Working with the PCF85063AT-ARD requires the kit contents, additional hardware, and a Windows PC workstation with installed software.

4.1 Kit contents

- Assembled and tested evaluation board in an anti-static bag
- Quick Start Guide

4.2 Assumptions

Familiarity with the I2C-bus is helpful but not required.

4.3 Static handling requirements

CAUTION

This device is sensitive to ElectroStatic Discharge (ESD). Therefore care should be taken during transport and handling. You must use a ground strap or touch the PC case or other grounded source before unpacking or handling the hardware.

4.4 Minimum system requirements

This evaluation board requires a Windows PC workstation. Meeting these minimum specifications should produce great results when working with this evaluation board.

- Computer with Windows 10
- One of three EVKs boards (MIMXRT1050-EVK, LPC55S69-EVK, 8MMINILPD4-EVK) along with the associated firmware / GUI software
- USB cable for power and data connection between PC and EVK board (if it is not included in the EVK package)

5 Getting to know the hardware

5.1 PCF85063AT-ARD features

- Connector for external access to I2C-bus
- Onboard user switch for oscillator stop test
- Onboard LED for interrupt pin monitoring
- Equipped with Arduino Uno R3 port for direct connection with Arduino devices
- Fully compliant with MIMXRT1050-EVK board, including GUI (Windows 10)
- Fully compliant with LPC55S69-EVK board, including GUI (Windows 10)
- Compliant with 8MMINILPD4-EVK board, including GUI (Windows 10)

Note:

For 8MMINILPD4-EVK board, it is necessary to use IMX8MMINI-IARD interposer board between the EVK and PCF85063AT-ARD daughter board (see IMX8MMINI-IARD user manual).

5.2 Kit featured components

The board is developed around the DUT IC, PCF85038AT (U1). The board also features an Arduino interface (J1, J4 to J6), which helps in powering the circuit, and the communication between the controller and DUT IC through an I2C-bus, with a maximum speed of 400 kHz. The I2C-bus is linked to the dedicated pins of the Arduino connector (J1) and to onboard connector (J38), allowing the user to access the I2C-bus from external. For more details, see PCF85063A data sheet.

The internal interrupt control of PC85063AT IC (pin 3) is connected to J5, pin 3. An onboard LED (D2) can be connected through J24 jumper to the interrupt line for monitoring purposes. The user switch SW1 allows the user to perform the oscillator stop test by pulling down to GND, the OSCI pin of DUT IC (pin 1). The internal clock signal of PCF85063AT is driven out through pin 7 (CLKOUT, push-pull configuration). The CLKOUT pin is connected to the Arduino connector J4 pin 1 through R35.

The board is powered through the Arduino connector J6 (pin 4 – 3.3 V, pin 6, 7 – GND). The power is applied to the DUT through J37 jumper placed on development board which allows power-off and current measurements. If C8 supercapacitor and R3 resistor (not populated) are installed on the board, the user can perform RTC back-up tests. R3 limits the charging current of the supercapacitor.

5.2.1 Board layout and component placement

Figure 1 represents the top silkscreen of the board.

The connectors of the Arduino port (J1, J4 to J6) are located on the bottom.

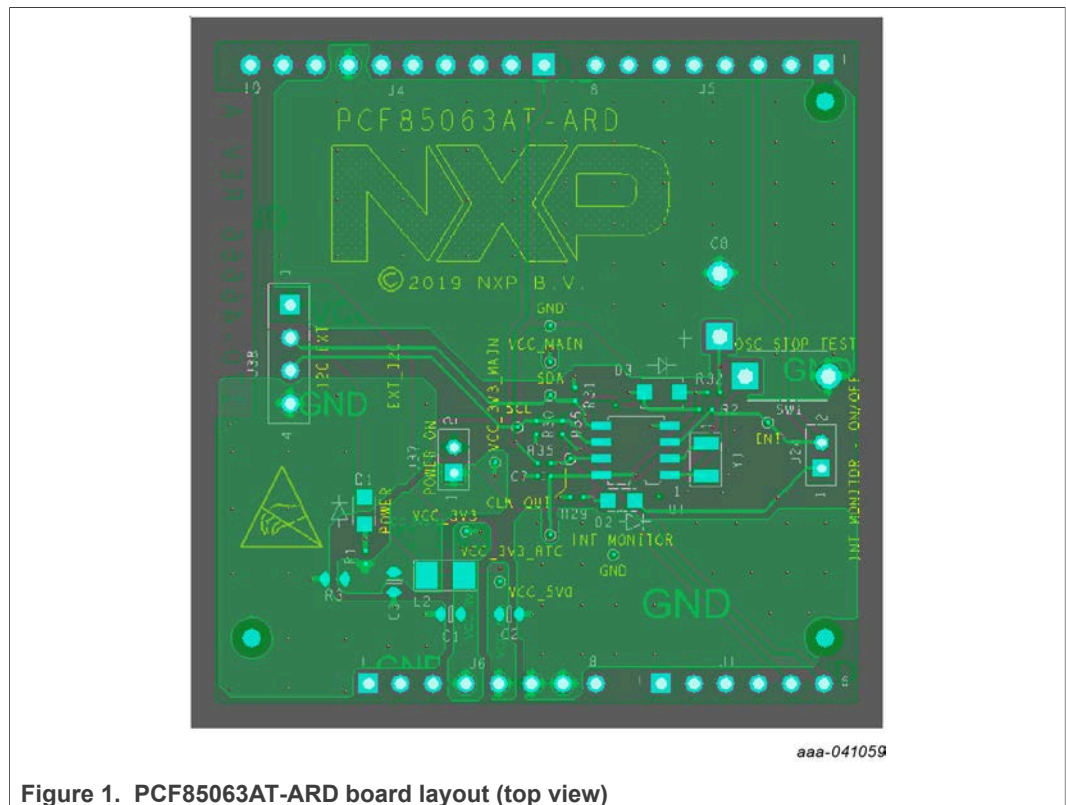

Figure 1. PCF85063AT-ARD board layout (top view)

See Figure 2 and Figure 3 for top and bottom view of PCF85063AT-ARD daughter card.

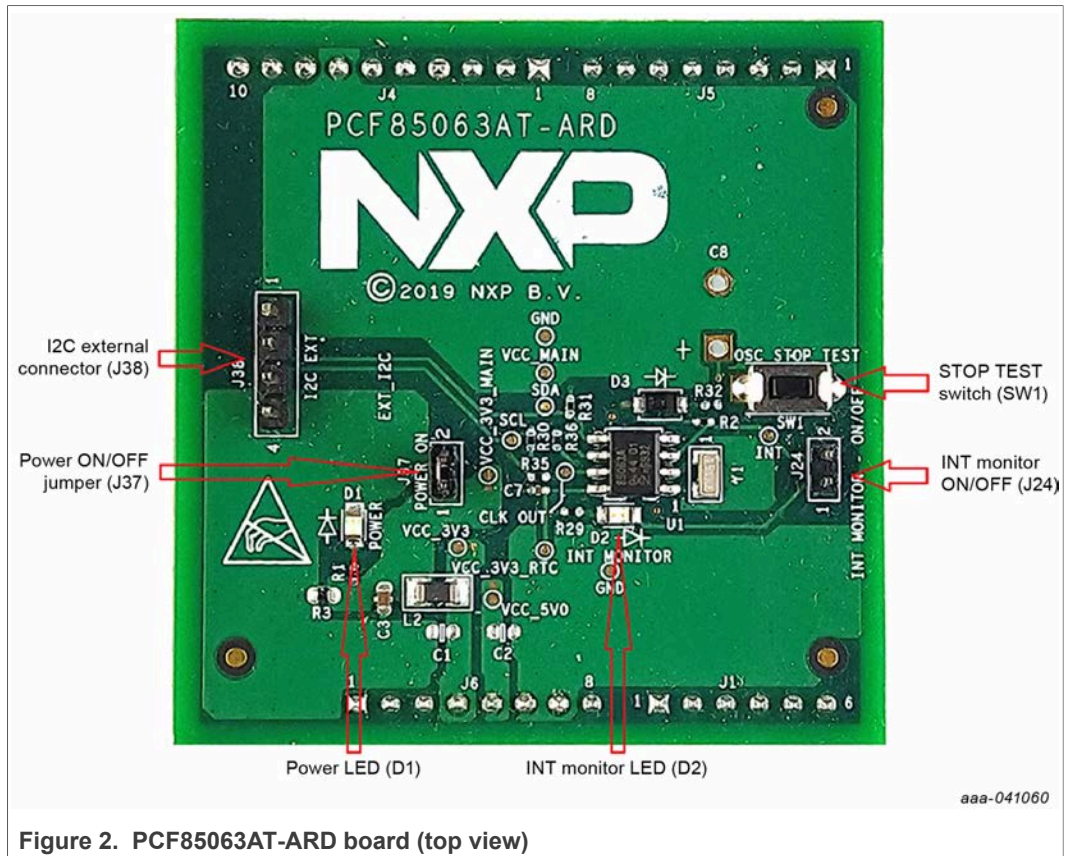
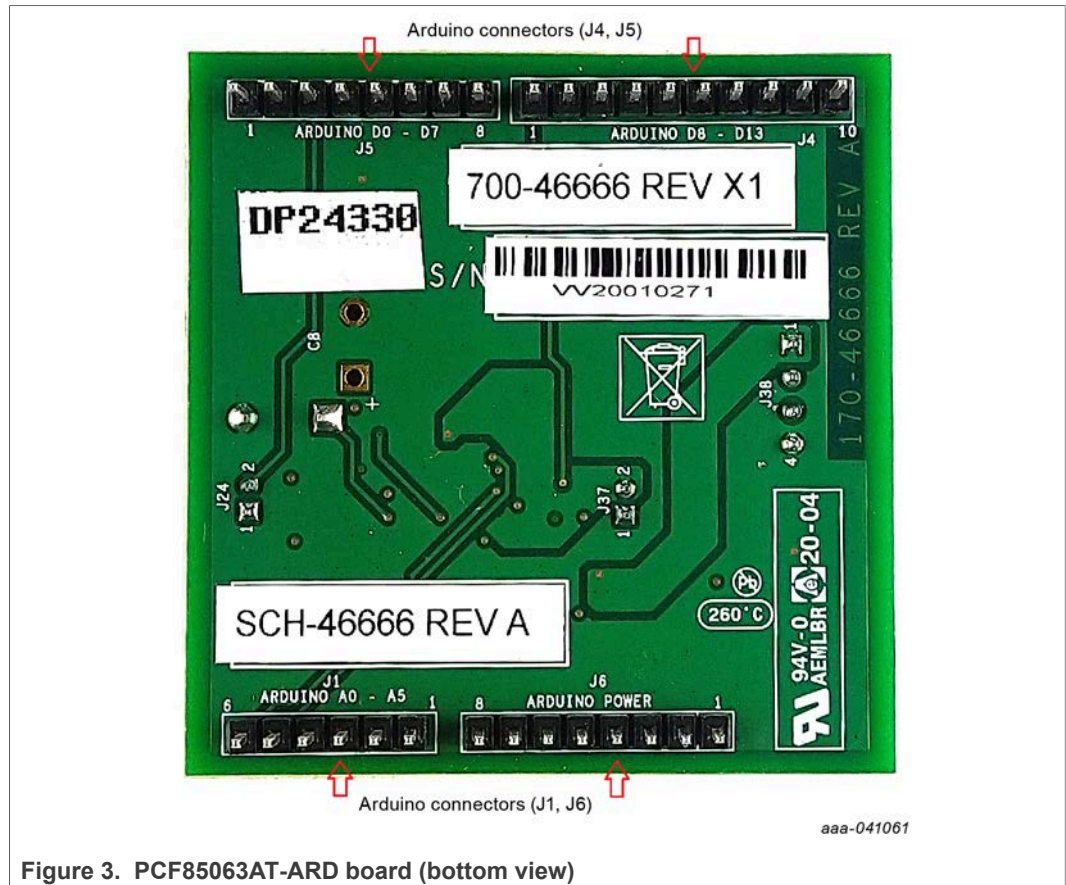

Figure 2. PCF85063AT-ARD board (top view)



5.2.2 Arduino port

J1, J4, J5, and J6 are the mated pin headers of Arduino UNO R3 connectors, having the same electrical function and placed on the board, so that the daughter board can be directly inserted in the Arduino port. The daughter board circuit is using only four signal lines. See [Table 1](#) for the pin chart of connectors, and the used lines in the circuit.

Table 1. Pin chart of Arduino connectors and their usage

Ref Design	#	Arduino label	PCF85063AT-ARD function
J6 (Power)	1	NC	Not used
	2	IOREF	Not used
	3	RESET	Not used
	4	3.3V	Power supply
	5	5V	Not used
	6	GND	Power supply return
	7	GND	Power supply return
	8	Vin	Not used
J1 (analog, digital, I2C)	1	A0	Not used
	2	A1	Not used
	3	A2	Not used
	4	A3	Not used
	5	A4 / SDA ^[1]	Used as I2C – SDA (I2C_3V3_SDA)
	6	A5 / SCL ^[1]	Used as I2C – SCL (I2C_SCL)

Table 1. Pin chart of Arduino connectors and their usage...continued

Ref Design	#	Arduino label	PCF85063AT-ARD function
J5 (digital, UART, PWM)	1	D0 / RX	Not used
	2	D1 / TX	Not used
	3	D2	RTC INT monitor (RTC_INT_B)
	4	D3 / PWM	Not used
	5	D4	Not used
	6	D5 / PWM	Not used
	7	D6 / PWM	Not used
	8	D7	Not used
J4 (mixed)	1	D8	RTC clock out (CLK_OUT)
	2	D9 / PWM	Not used
	3	D10 / SS / PWM	Not used
	4	D11 / MOSI / PWM	Not used
	5	D12 / MISO	Not used
	6	D13 / SCK	Not used
	7	GND	Power supply return
	8	AREF	Not used
	9	A4 / SDA ^[1]	Not used
	10	A5 / SCL ^[1]	Not used

[1] A4 / SDA common line for J2 – 5 and J4 – 9. A5 / SCL common line for J2 – 6 and J4 – 10.

5.3 Schematic, board layout and bill of materials

The schematic, board layout and bill of materials for the PCF85063AT-ARD evaluation board are available at <http://www.nxp.com/PCF85063AT-ARD>.

6 Installing and configuring software and tools

PCF85063AT-ARD evaluation board is designed and built as a daughter board able to work with a mother board equipped with an Arduino port. The board is built to be fully compatible with the following NXP evaluation boards:

- MIMXRT1050-EVK
- LPC55S69-EVK
- 8MMINILPD4-EVK

The required firmware for the EVK boards is available for download at www.nxp.com. Before starting a pair EVK – PCF85063AT-ARD, the EVK motherboard must be programmed with the corresponding firmware package. Additionally, a GUI application (Windows 10) is available for download from the same NXP site, allowing rapid testing and operation of PCF85063AT-ARD daughter board through one of the EVKs.

The GUI application is common for all three EVKs and for the PCF85x63 RTC development card family, manufactured by NXP (PCF85063AT, PCF85063TP, and PCF85263ATL ICs). For details regarding installation of the EVK firmware and GUI host software, see [UM11581, Arduino shields GUI and firmware installation manual](#).

Once the software is installed, the first step is to select the correct combination of EVK – PCF85063AT-ARD daughter card from the GUI, and then the board can be controlled from the GUI interface. See [Section 7 "Configuring the hardware"](#) and [Section 8 "GUI description"](#) for more details.

7 Configuring the hardware

7.1 Using PCF85063AT-ARD with MIMXRT1050-EVK board

Figure 4 shows the required hardware for operation of the PCF85063AT-ARD daughter board with MIMXRT1050-EVK.

- One MIMXRT1050-EVK board
- One PCF85063AT-ARD daughter board
- One USB-A / USB Micro-B cable
- PC with Windows 10 operating system

The MIMXRT1050-EVK mother board can be powered through three different connectors: using an external 5.0 V DC power supply, connected to J2 barrel power connector, directly from an USB port through J9 USB Micro-B connector (J9), or from the same USB port through J28 connector. J28 can be used as a debug connector, therefore using J28, through the same USB cable, the EVK can be powered and in the same time linked to PC for data exchange. The older USB ports (from PC) are not able to deliver the necessary current (500 mA), before establishing the communication, use an external power supply (connected to J2). From J1 (see Figure 4), the user can select the power configuration for the mother board. For more details, see [i.MX RT1050 Evaluation Kit](#).

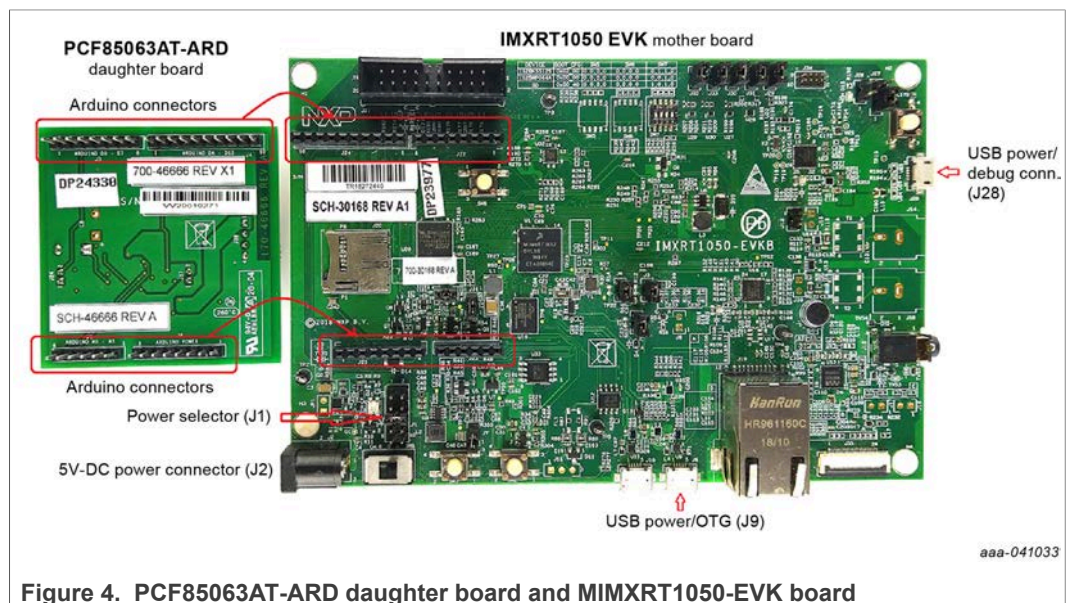

Figure 4. PCF85063AT-ARD daughter board and MIMXRT1050-EVK board

To configure the hardware and workstation, complete the following procedure:

1. Configure the suitable power configuration of EVK (J1). If the user is using J28 for power supply, the J1 jumper is placed in position 5-6. If the user uses an external power supply (connected to J2), the jumper J1 is placed in position 1-2.
2. Insert the PCF85063AT-ARD daughter card on the Arduino port of the EVK (see Figure 4).
3. Connect the MIMXRT1050-EVK board using J28 connector to USB port of the computer.
4. Install the IMXRT1050 target firmware (download from NXP site and see [UM11581](#) for step-by-step instructions).

5. Install GUI application on PC (see [UM11581, Arduino shields GUI and firmware installation manual](#)).
6. Open the GUI application to operate the device from the PC. For details regarding GUI operation see [Section 8 "GUI description"](#).

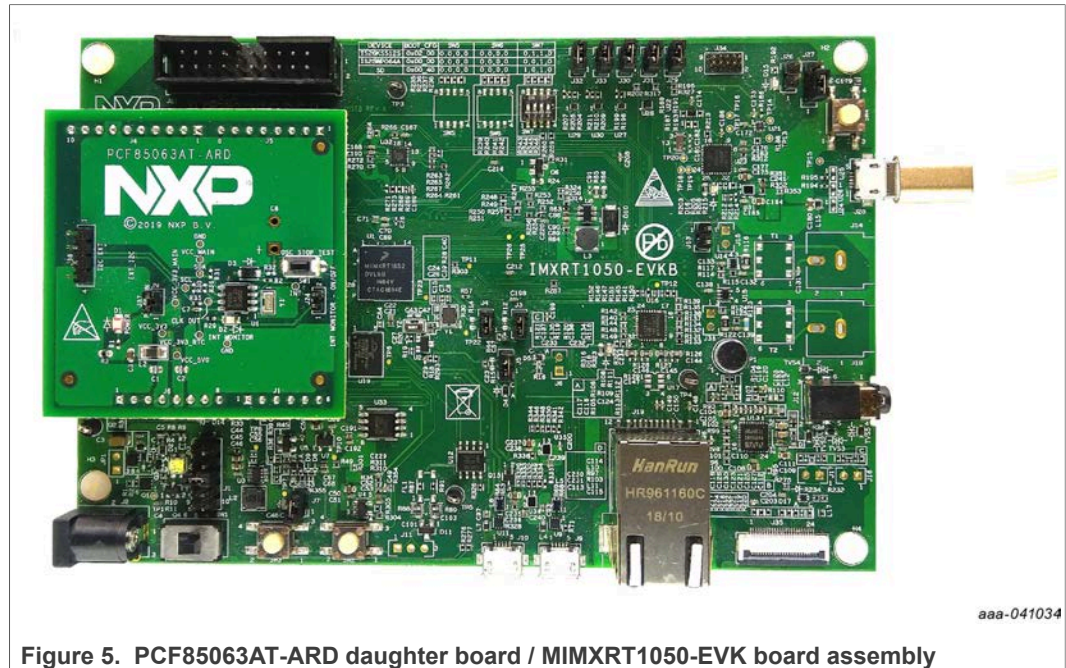

Figure 5. PCF85063AT-ARD daughter board / MIMXRT1050-EVK board assembly

7.2 Using PCF85063AT-ARD with LPC55S69-EVK board

[Figure 6](#) shows the required hardware for operation of the PCF85063AT-ARD and LPC55S69-EVK board.

- One LPC55S69-EVK board
- One PCF85063AT-ARD daughter board
- One USB-A / USB Micro-B cable
- PC with Windows 10 operating system

The LPC55S69-EVK board is equipped with four USB Micro-B connectors: P5, P6, P9, and P10. The board can be powered through any USB port. Using P6 USB connector to connect the board to the PC, the bring-up operation is simplified because P6 is designated for debug, and the USB cable accomplishes two tasks in the same time: powering the board, and data link between the LPC55S69-EVK board and PC. For more details, see [LPCXpresso55S69 Development Board](#).

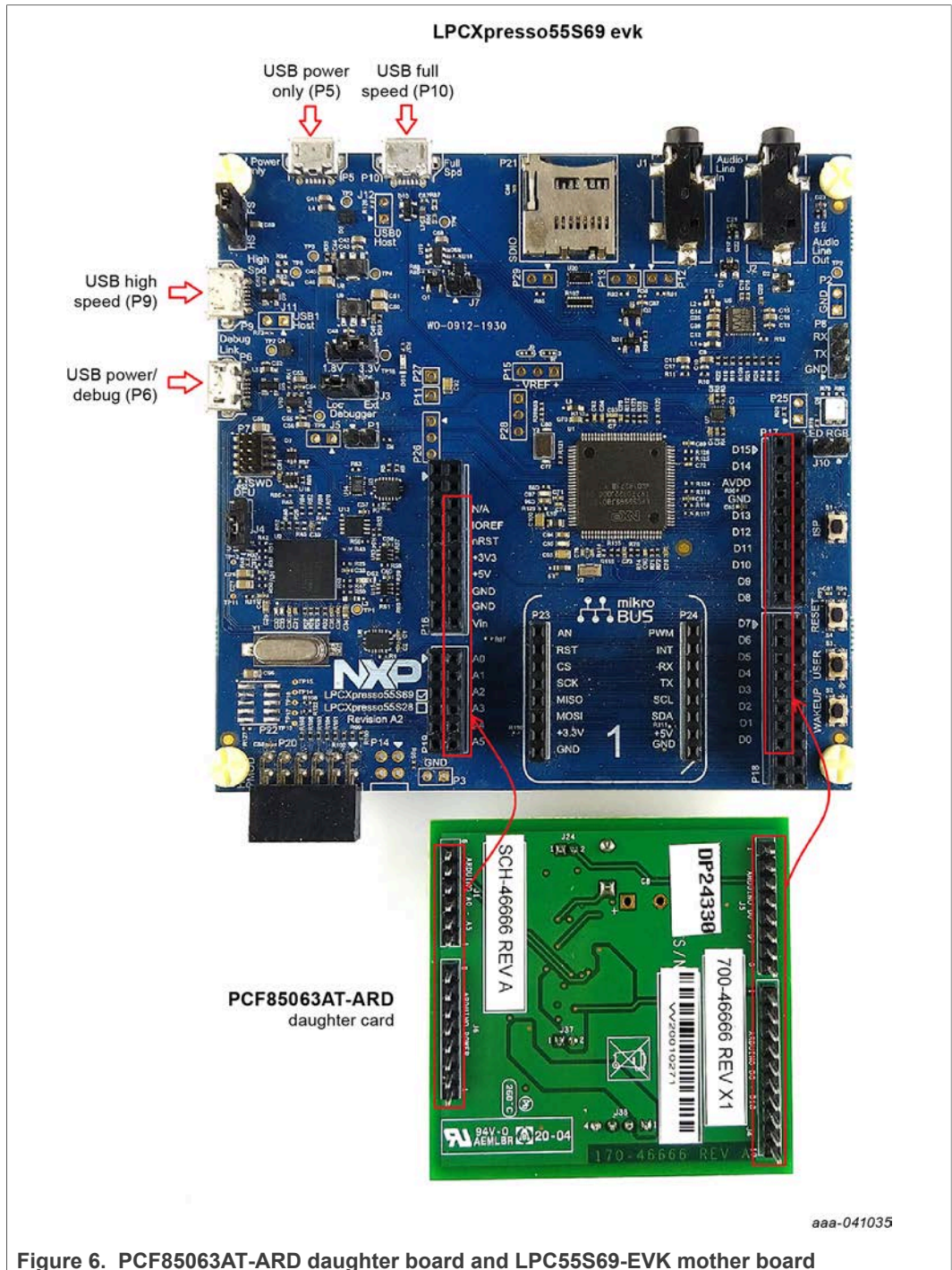

Figure 6. PCF85063AT-ARD daughter board and LPC55S69-EVK mother board

To configure the hardware and workstation, complete the following procedure:

1. Insert the PCF85063AT-ARD daughter card to P16 – P19 connectors located on LPC55S69-EVK development board (see the marked pins of P16 – P19, [Figure 6](#)).
2. Connect the development board using port P6 USB port of PC.
3. Install the LPCXpresso55S69 target firmware (download from NXP site and see [UM11581](#) for step-by-step instructions).

4. Install GUI application on PC (see [UM11581, Arduino shields GUI and firmware installation manual](#)).
5. Open the GUI application to operate the device from the PC. For details regarding GUI operation see [Section 8 "GUI description"](#).

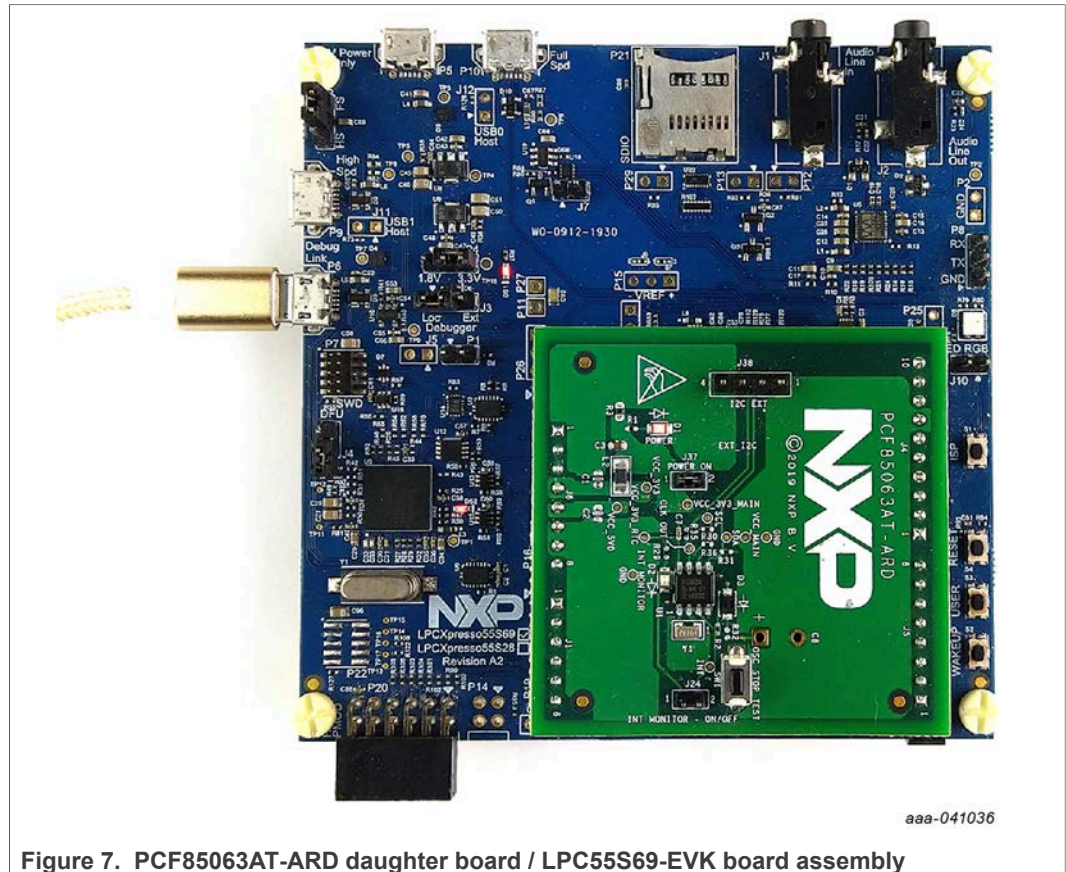

Figure 7. PCF85063AT-ARD daughter board / LPC55S69-EVK board assembly

7.3 Using PCF85063AT-ARD with 8MMINILPD4-EVK board

If 8MMINILPD4-EVK board is used for PCF85063AT-ARD operation, a third board (IMX8MMINI-IARD interposer board) must be used, especially designed and built as EVK – daughter board interconnection. The EVK board 8MMINILPD4-EVK is not equipped with Arduino port, instead has a 2x20 pin expansion connector (J1003, see 8MMINILPD4-EVK user manual). J1003 is a multipurpose port, containing different digital I/O lines, including specialized I2C and SPI buses. Starting from the expansion connector pin chart, an Arduino port interposer board was developed.

In [Figure 8](#) it can be easy to observe, along the EVK and daughter board a third board is included in the setup assembly. This is IMX8MMINI-IARD interposer board. To power-up and operate the setup, it is also necessary to have one USB-C cable for power connected to Port 2 of the EVK board. The board is equipped with power switch (SW101) which shall be positioned in ON position to power-up the setup. Data communication is assured through a second (USB Micro-B) cable connected to PC and debug port of the EVK (J901).

To attach the daughter board to the EVK, it is necessary to use the IMX8MMINI-IARD interposer boards by plugging PCF85063AT-ARD to the Arduino connector of the interposer, and then the interposer to expansion connector (J1003), located

on the i.MX8MMINI EVK board (see [Figure 8](#)). The user may find more details regarding power-up and operation of the setup assembly, in 8MMINILPD4-EVK user manual (IMX8MMEVKHUG.pdf) and IMX8MMINI-IARD user manual. The files can be downloaded from [NXP site](#).

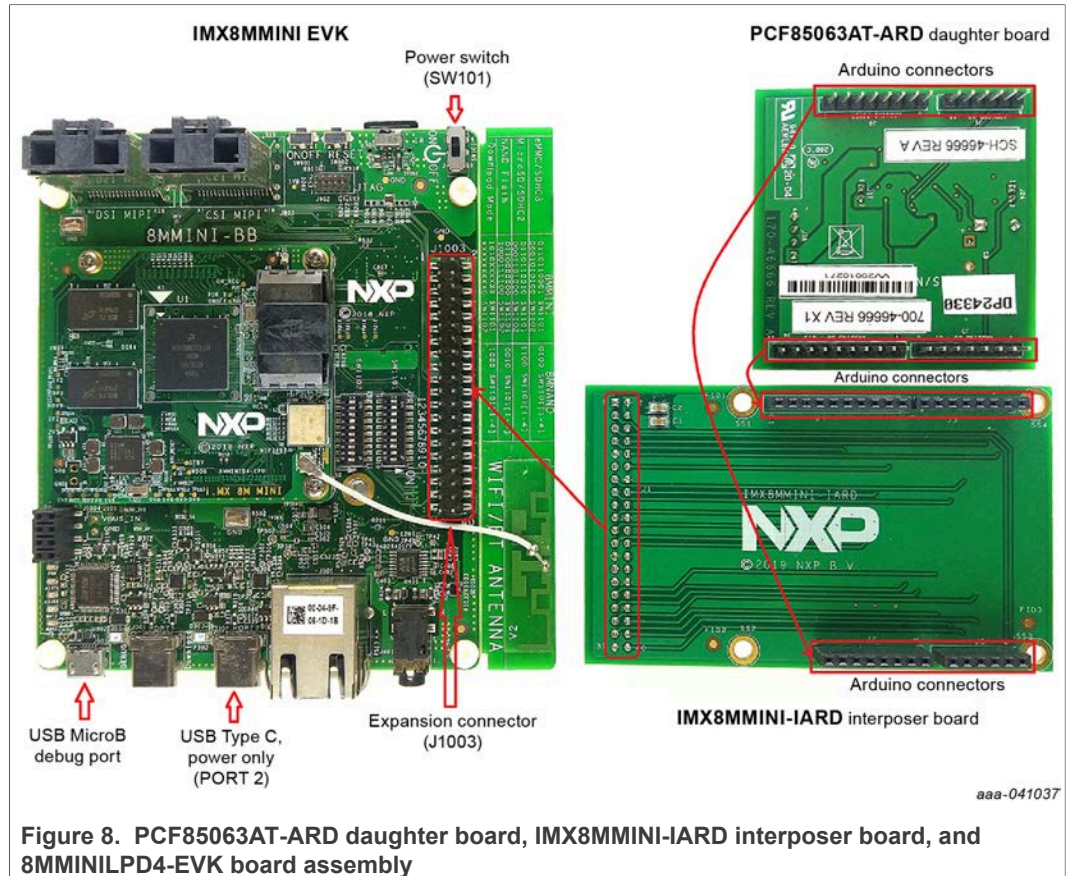

Figure 8. PCF85063AT-ARD daughter board, IMX8MMINI-IARD interposer board, and 8MMINILPD4-EVK board assembly

To configure the hardware and workstation, complete the following procedure:

1. Insert the PCF85063AT-ARD on IMX8MMINI-IARD interposer board Arduino connectors (located on the top side).
2. Attach the obtained assembly to EVK (plug J1 connector of IMX8MMINI-IARD, located on the bottom side into J1003 expansion board located on the top side of 8MMINILPD4-EVK board).
3. Power up the EVK board using a USB Type C cable attached to Port 2.
4. Connect the EVK to the PC, using a USB Micro-B cable, attached to J901 debug port.
5. Place SW101 in On position to power up the boards.
6. Install the MIMXRT1050 target firmware (download from NXP site and see [UM11581](#) for step-by-step instructions).
7. Install GUI application on PC. Note that an additional USB driver from FTDI Chip (ftdichip.com/drivers/d2xx-drivers) should be installed.
8. Open the GUI application, to operate the device from the PC. For more details, see [Section 8 "GUI description"](#).



Figure 9. PCF85063AT-ARD daughter board / 8MMINILPD4-EVK board operation

7.4 Using PCF85063AT-ARD with another Arduino device

The PCF85063AT-ARD daughter board can be operated with different EVK boards, which has an Arduino port. There are two options to connect the board: using other EVK equipped with an Arduino port, and an EVK without Arduino port.

In the first case, a firmware is developed according to PCF85063AT specifications, and then PCF85063AT-ARD daughter board is attached to the EVK to operate the board.

In the second case, using the pin chart of Arduino connectors (see [Table 1](#)), make the necessary electrical connections (for power, I²C bus and control lines), and develop the desired firmware compliant with IC specifications. Use PCF85063A data sheet to read details about internal registers of PCF85063AT and data exchange between internal controller and the EVK. Ensure that the electrical connections are accurate and avoid data conflicts on the signal lines, in order to prevent IC damage.

8 GUI description

A GUI application is available for the three EVK boards from NXP Semiconductors. The application is common for all EVKs / development boards.

This section describes the GUI application and how the user can control the PCF85063AT-ARD daughter board from the graphical interface. First, install the GUI package and software on the PC (Windows 10). For more details, see [UM11581](#). Once installation is complete, ensure that one of the three EVK with attached PCF85063AT-ARD daughter board is connected to PC and powered-on. Open NXP_GUI (PCF85063TP, PCF85263ATL, PCF85063A) application.

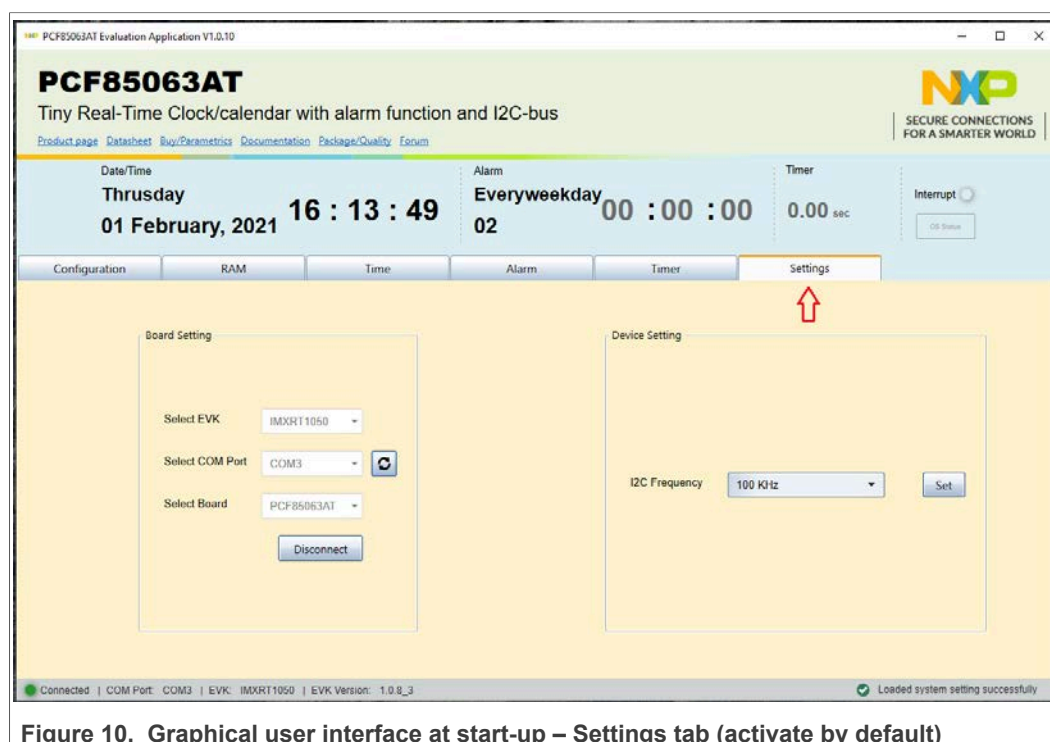

Figure 10. Graphical user interface at start-up – Settings tab (activate by default)

The GUI application starts with **Settings** tab (marked with red arrow). The left side of the window displays **Board setting**.

- **Select EVK:** displays list of EVKs. Selecting a wrong EVK board causes the connection to fail and a pop-up window with the message: “*Unable to Connect with EVK*” appears on the screen.
- **Select COM Port:** displays port selected for the communication. The port is automatically selected by the system (**COM 3**).
- **Select Board:** allows the user to select the correct daughter board (the application can support three different boards). In [Figure 10](#), the selected board is **PCF85063AT**.

Click **Connect**, to establish the connection with the EVK. Selecting the wrong EVK or daughter board, causes the connection to fail and a pop-up window with the message: “*Unable to Connect with Daughter Card*” appears on the screen.

The bottom side of the GUI, displays a status bar showing the connection status between PC and the EVK.

The left side of the window displays **Device setting**.

- **I2C Frequency:** allows the user to select the speed of I2C-bus (standard – 100 kHz, Fm - 400 kHz, or Fm+ - 1.0 MHz)

Click **Set** to confirm the selection.

8.1 Configuration

The **Configuration** tab displays following three parameters:

- Control Register1
- Control Register2
- Offset Register

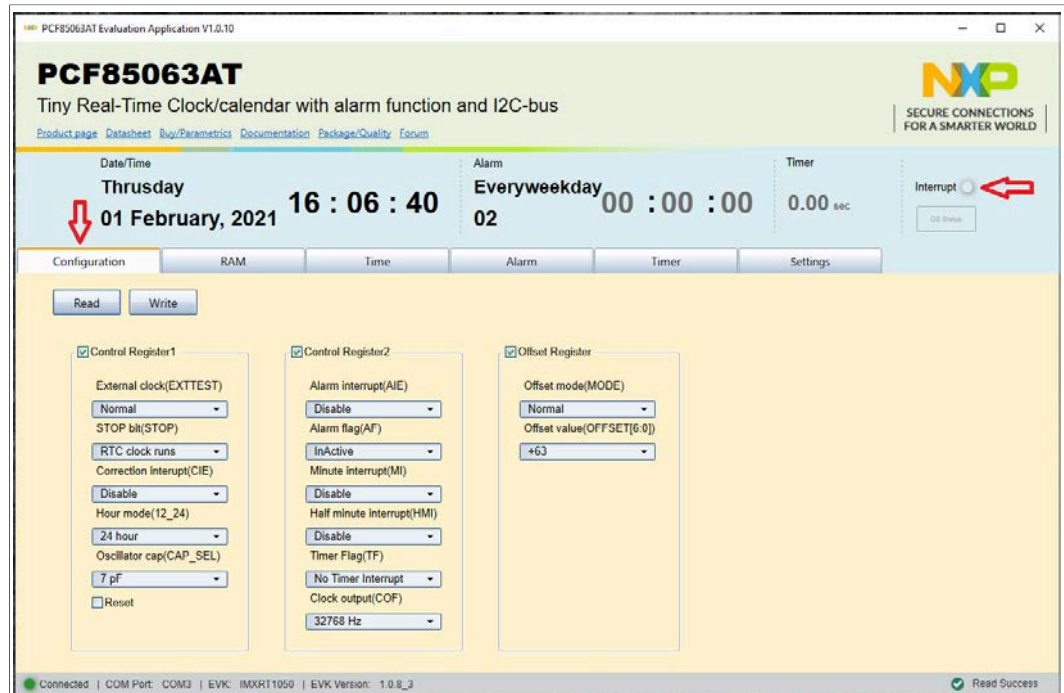

Figure 11. Graphical user interface – Configuration

A series of parameters can be set by clicking the corresponding tabs and selecting the desired setting for every register. To find more details about the parameters and the register map, see DUT IC (PCF85063A) data sheet.

Once parameters are set, by clicking **Write**, through I2C-bus the registers of the IC are written. The **Read** button brings back the status of the control register on the GUI interface.

The **Interrupt indicator** is monitoring the INT line (pin 3 of the DUT IC) status. The indicator is replicating the status of INT monitor LED (D2) located on the daughter board.

8.2 RAM

The **RAM** tab displays the options to set RAM byte.

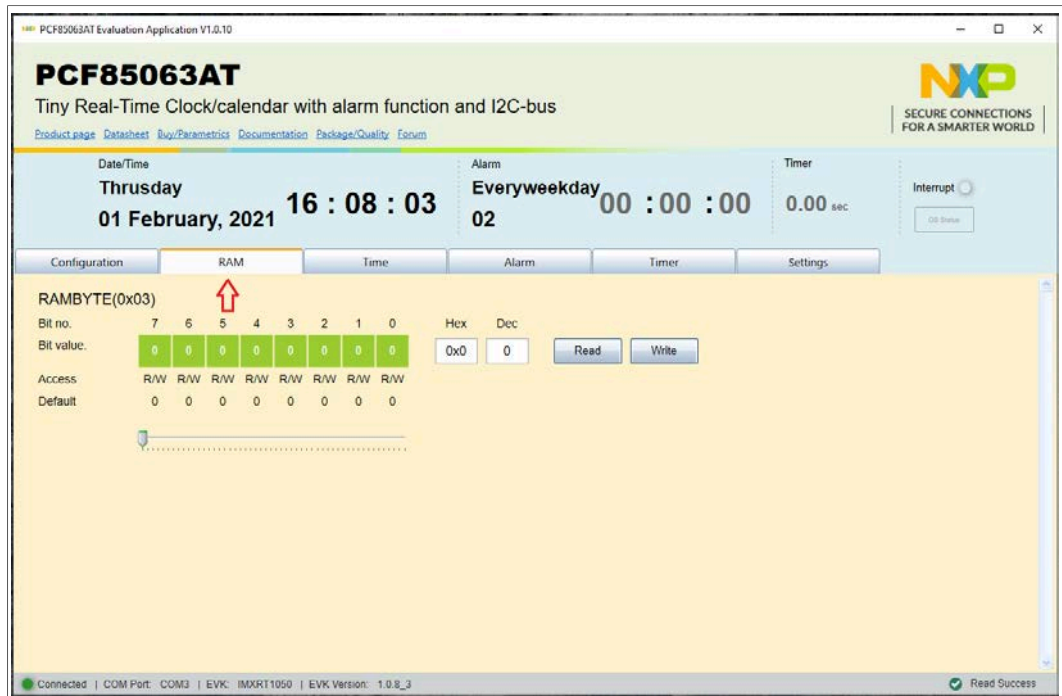

Figure 12. Graphical user interface – RAM

The PCF85063A IC has a general-purpose RAM byte used by the host device. There are three modes to set the RAM byte: by clicking individually on the corresponding bit (the green squares), by writing the desired value in the “Hex” or “Dec” box.

The **Write** button allows the user to write the data in the memory of the IC, and **READ** button brings back the data from the memory.

8.3 Time

The **Time** tab allows the user to set the date and the time of the RTC.

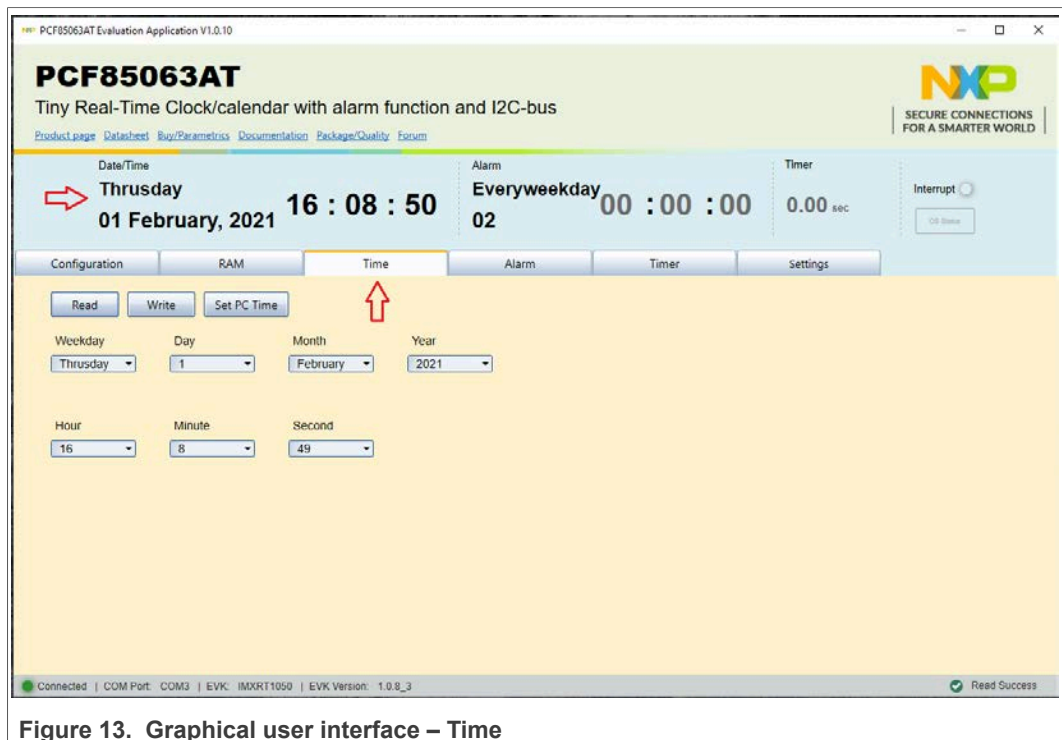

Figure 13. Graphical user interface – Time

- **Read:** allows the user to bring back the data from the RTC
- **Write:** sets the RTC registry with the data set by the user
- **Set PC Time:** sets the RTC registry with the current time and date of the PC

In the upper left side of the window, the current data of the RTC registry is displayed. For more details, see PCF85063A data sheet.

8.4 Alarm

The **Alarm** tab allows the user to set an alarm time / date in the RTC registry.

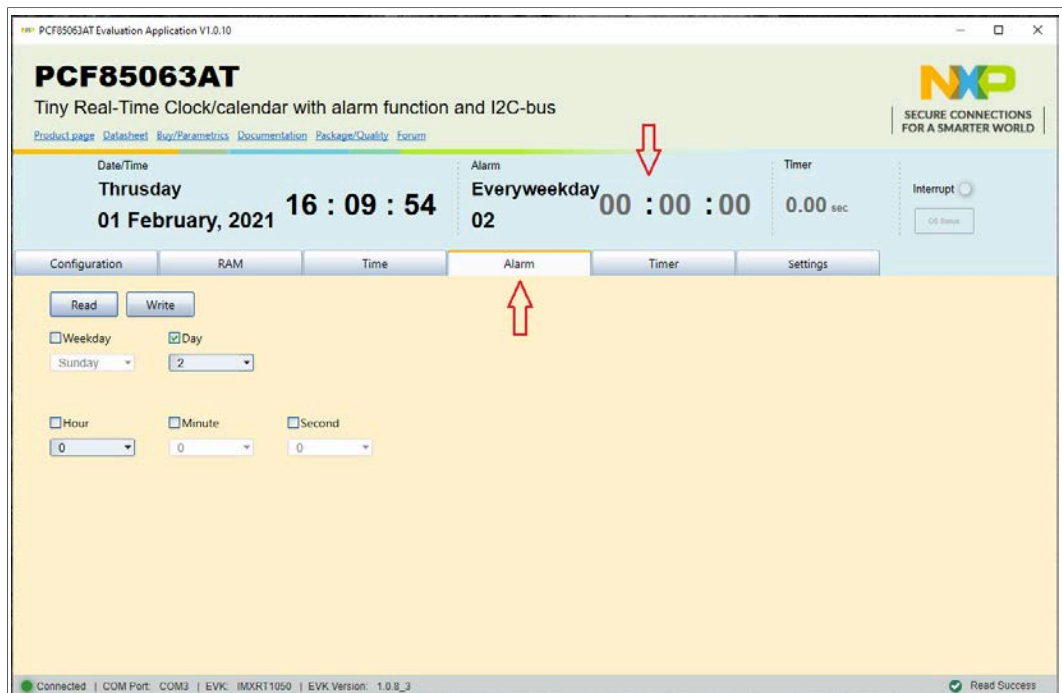

Figure 14. Graphical user interface – Alarm

The current data regarding the alarm parameters are displayed in the upper right side, indicated by the red arrow, (see [Figure 14](#)).

The **Write** button sets the RTC registry with the data, and **Read** brings back the data from the RTC. For more details, see PCF85063A data sheet.

8.5 Timer

The Timer tab displays the options for setting or writing the values in Hexadecimal or Decimal representation.

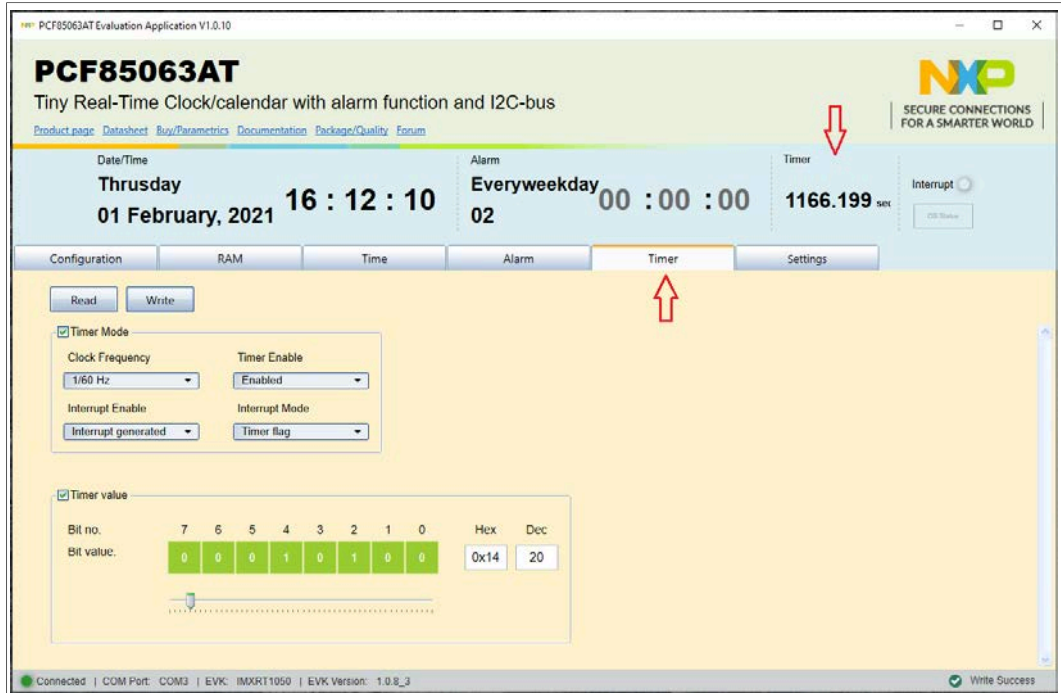

Figure 15. Graphical user interface – Timer

The parameters are set using the GUI, and sent to RTC by clicking **Write** button. The **Read** button allows the user to bring back the data from the RTC.

The Timer value bits can be set individually (by clicking the green squares), or writing the values in Hexadecimal or Decimal representation. The current value of the timer is displayed in the top right corner of the window (see [Figure 15](#)).

9 Abbreviations

Table 2. Abbreviations

Abbreviations	Description
DUT	Device Under Test
ESD	Electrostatic Discharge
GUI	Graphical User Interface
I2C-bus	Inter-Integrated Circuit bus
IC	Integrated Circuit
LED	Light Emitting Diode
RTC	Real-time Clock
USB	Universal Serial Bus

10 References

- [1] **MIMXRT1050-EVK** — [i.MX RT1050 Evaluation Kit](#)
- [2] **LPC55S69-EVK** — [LPCXpresso55S69 Development Board](#)
- [3] **8MMINILPD4-EVK** — [Evaluation Kit for the i.MX 8M Mini Applications Processor](#)

11 Legal information

11.1 Definitions

Draft — A draft status on a document indicates that the content is still under internal review and subject to formal approval, which may result in modifications or additions. NXP Semiconductors does not give any representations or warranties as to the accuracy or completeness of information included in a draft version of a document and shall have no liability for the consequences of use of such information.

11.2 Disclaimers

Limited warranty and liability — Information in this document is believed to be accurate and reliable. However, NXP Semiconductors does not give any representations or warranties, expressed or implied, as to the accuracy or completeness of such information and shall have no liability for the consequences of use of such information. NXP Semiconductors takes no responsibility for the content in this document if provided by an information source outside of NXP Semiconductors. In no event shall NXP Semiconductors be liable for any indirect, incidental, punitive, special or consequential damages (including - without limitation - lost profits, lost savings, business interruption, costs related to the removal or replacement of any products or rework charges) whether or not such damages are based on tort (including negligence), warranty, breach of contract or any other legal theory. Notwithstanding any damages that customer might incur for any reason whatsoever, NXP Semiconductors' aggregate and cumulative liability towards customer for the products described herein shall be limited in accordance with the Terms and conditions of commercial sale of NXP Semiconductors.

Right to make changes — NXP Semiconductors reserves the right to make changes to information published in this document, including without limitation specifications and product descriptions, at any time and without notice. This document supersedes and replaces all information supplied prior to the publication hereof.

Suitability for use — NXP Semiconductors products are not designed, authorized or warranted to be suitable for use in life support, life-critical or safety-critical systems or equipment, nor in applications where failure or malfunction of an NXP Semiconductors product can reasonably be expected to result in personal injury, death or severe property or environmental damage. NXP Semiconductors and its suppliers accept no liability for inclusion and/or use of NXP Semiconductors products in such equipment or applications and therefore such inclusion and/or use is at the customer's own risk.

Applications — Applications that are described herein for any of these products are for illustrative purposes only. NXP Semiconductors makes no representation or warranty that such applications will be suitable for the specified use without further testing or modification. Customers are responsible for the design and operation of their applications and products using NXP Semiconductors products, and NXP Semiconductors accepts no liability for any assistance with applications or customer product design. It is customer's sole responsibility to determine whether the NXP Semiconductors product is suitable and fit for the customer's applications and products planned, as well as for the planned application and use of customer's third party customer(s). Customers should provide appropriate design and operating safeguards to minimize the risks associated with their applications and products. NXP Semiconductors does not accept any liability related to any default, damage, costs or problem which is based on any weakness or default in the customer's applications or products, or the application or use by customer's third party customer(s). Customer is

responsible for doing all necessary testing for the customer's applications and products using NXP Semiconductors products in order to avoid a default of the applications and the products or of the application or use by customer's third party customer(s). NXP does not accept any liability in this respect.

Export control — This document as well as the item(s) described herein may be subject to export control regulations. Export might require a prior authorization from competent authorities.

Evaluation products — This product is provided on an "as is" and "with all faults" basis for evaluation purposes only. NXP Semiconductors, its affiliates and their suppliers expressly disclaim all warranties, whether express, implied or statutory, including but not limited to the implied warranties of non-infringement, merchantability and fitness for a particular purpose. The entire risk as to the quality, or arising out of the use or performance, of this product remains with customer. In no event shall NXP Semiconductors, its affiliates or their suppliers be liable to customer for any special, indirect, consequential, punitive or incidental damages (including without limitation damages for loss of business, business interruption, loss of use, loss of data or information, and the like) arising out of the use of or inability to use the product, whether or not based on tort (including negligence), strict liability, breach of contract, breach of warranty or any other theory, even if advised of the possibility of such damages. Notwithstanding any damages that customer might incur for any reason whatsoever (including without limitation, all damages referenced above and all direct or general damages), the entire liability of NXP Semiconductors, its affiliates and their suppliers and customer's exclusive remedy for all of the foregoing shall be limited to actual damages incurred by customer based on reasonable reliance up to the greater of the amount actually paid by customer for the product or five dollars (US\$5.00). The foregoing limitations, exclusions and disclaimers shall apply to the maximum extent permitted by applicable law, even if any remedy fails of its essential purpose.

Translations — A non-English (translated) version of a document is for reference only. The English version shall prevail in case of any discrepancy between the translated and English versions.

Security — Customer understands that all NXP products may be subject to unidentified or documented vulnerabilities. Customer is responsible for the design and operation of its applications and products throughout their lifecycles to reduce the effect of these vulnerabilities on customer's applications and products. Customer's responsibility also extends to other open and/or proprietary technologies supported by NXP products for use in customer's applications. NXP accepts no liability for any vulnerability. Customer should regularly check security updates from NXP and follow up appropriately. Customer shall select products with security features that best meet rules, regulations, and standards of the intended application and make the ultimate design decisions regarding its products and is solely responsible for compliance with all legal, regulatory, and security related requirements concerning its products, regardless of any information or support that may be provided by NXP. NXP has a Product Security Incident Response Team (PSIRT) (reachable at PSIRT@nxp.com) that manages the investigation, reporting, and solution release to security vulnerabilities of NXP products.

11.3 Trademarks

Notice: All referenced brands, product names, service names and trademarks are the property of their respective owners.

I²C-bus — logo is a trademark of NXP B.V.

NXP — wordmark and logo are trademarks of NXP B.V.

Tables

Tab. 1.	Pin chart of Arduino connectors and their usage8	Tab. 2.	Abbreviations21
---------	--	---------	-----------------------

Figures

Fig. 1.	PCF85063AT-ARD board layout (top view) 6	Fig. 8.	PCF85063AT-ARD daughter board, IMX8MMINI-IARD interposer board, and 8MMINILPD4-EVK board assembly 14
Fig. 2.	PCF85063AT-ARD board (top view) 7	Fig. 9.	PCF85063AT-ARD daughter board / 8MMINILPD4-EVK board operation 15
Fig. 3.	PCF85063AT-ARD board (bottom view) 8	Fig. 10.	Graphical user interface at start-up – Settings tab (activate by default) 16
Fig. 4.	PCF85063AT-ARD daughter board and MIMXRT1050-EVK board10	Fig. 11.	Graphical user interface – Configuration 17
Fig. 5.	PCF85063AT-ARD daughter board / MIMXRT1050-EVK board assembly11	Fig. 12.	Graphical user interface – RAM 18
Fig. 6.	PCF85063AT-ARD daughter board and LPC55S69-EVK mother board 12	Fig. 13.	Graphical user interface – Time 19
Fig. 7.	PCF85063AT-ARD daughter board / LPC55S69-EVK board assembly 13	Fig. 14.	Graphical user interface – Alarm20
		Fig. 15.	Graphical user interface – Timer21

Contents

1	Revision history	2
2	Introduction	4
3	Finding kit resources and information on the NXP web site	4
3.1	Collaborate in the NXP community	4
4	Getting ready	4
4.1	Kit contents	4
4.2	Assumptions	4
4.3	Static handling requirements	5
4.4	Minimum system requirements	5
5	Getting to know the hardware	5
5.1	PCF85063AT-ARD features	5
5.2	Kit featured components	5
5.2.1	Board layout and component placement	6
5.2.2	Arduino port	8
5.3	Schematic, board layout and bill of materials	9
6	Installing and configuring software and tools	9
7	Configuring the hardware	10
7.1	Using PCF85063AT-ARD with MIMXRT1050-EVK board	10
7.2	Using PCF85063AT-ARD with LPC55S69-EVK board	11
7.3	Using PCF85063AT-ARD with 8MMINILPD4-EVK board	13
7.4	Using PCF85063AT-ARD with another Arduino device	15
8	GUI description	15
8.1	Configuration	17
8.2	RAM	17
8.3	Time	18
8.4	Alarm	19
8.5	Timer	20
9	Abbreviations	21
10	References	21
11	Legal information	22

Please be aware that important notices concerning this document and the product(s) described herein, have been included in section 'Legal information'.

© NXP B.V. 2021.

All rights reserved.

For more information, please visit: <http://www.nxp.com>

For sales office addresses, please send an email to: salesaddresses@nxp.com

Date of release: 19 February 2021
Document identifier: UM11578