

Touch Sensing Software

Electrode Graphing Tool

Users Guide

Document Number:TSSEGTUG
Rev. 1
07/2009



How to Reach Us:

Home Page:

www.freescale.com

E-mail:

support@freescale.com

USA/Europe or Locations Not Listed:

Freescale Semiconductor
Technical Information Center, CH370
1300 N. Alma School Road
Chandler, Arizona 85224
+1-800-521-6274 or +1-480-768-2130
support@freescale.com

Europe, Middle East, and Africa:

Freescale Halbleiter Deutschland GmbH
Technical Information Center
Schatzbogen 7
81829 Muenchen, Germany
+44 1296 380 456 (English)
+46 8 52200080 (English)
+49 89 92103 559 (German)
+33 1 69 35 48 48 (French)
support@freescale.com

Japan:

Freescale Semiconductor Japan Ltd.
Headquarters
ARCO Tower 15F
1-8-1, Shimo-Meguro, Meguro-ku,
Tokyo 153-0064, Japan
0120 191014 or +81 3 5437 9125
support.japan@freescale.com

Asia/Pacific:

Freescale Semiconductor China Ltd.
Exchange Building 23F
No. 118 Jianguo Road
Chaoyang District
Beijing 100022
China
+86 10 5879 8000
support.asia@freescale.com

For Literature Requests Only:

Freescale Semiconductor Literature Distribution Center
1-800-441-2447 or 303-675-2140
Fax: 303-675-2150
LDCForFreescaleSemiconductor@hibbertgroup.com

Information in this document is provided solely to enable system and software implementers to use Freescale Semiconductor products. There are no express or implied copyright licenses granted hereunder to design or fabricate any integrated circuits or integrated circuits based on the information in this document.

Freescale Semiconductor reserves the right to make changes without further notice to any products herein. Freescale Semiconductor makes no warranty, representation or guarantee regarding the suitability of its products for any particular purpose, nor does Freescale Semiconductor assume any liability arising out of the application or use of any product or circuit, and specifically disclaims any and all liability, including without limitation consequential or incidental damages. "Typical" parameters that may be provided in Freescale Semiconductor data sheets and/or specifications can and do vary in different applications and actual performance may vary over time. All operating parameters, including "Typicals", must be validated for each customer application by customer's technical experts. Freescale Semiconductor does not convey any license under its patent rights nor the rights of others. Freescale Semiconductor products are not designed, intended, or authorized for use as components in systems intended for surgical implant into the body, or other applications intended to support or sustain life, or for any other application in which the failure of the Freescale Semiconductor product could create a situation where personal injury or death may occur. Should Buyer purchase or use Freescale Semiconductor products for any such unintended or unauthorized application, Buyer shall indemnify and hold Freescale Semiconductor and its officers, employees, subsidiaries, affiliates, and distributors harmless against all claims, costs, damages, and expenses, and reasonable attorney fees arising out of, directly or indirectly, any claim of personal injury or death associated with such unintended or unauthorized use, even if such claim alleges that Freescale Semiconductor was negligent regarding the design or manufacture of the part.



Freescale™ and the Freescale logo are trademarks of Freescale Semiconductor, Inc. ARC, the ARC logo, ARCangel, ARCform, ARChitect, ARCcompact, ARCtangent, BlueForm, CASSEIA, High C/C++, High C++, iCon186, MetaDeveloper, MQX, Precise Solution, Precise/BlazeNet, Precise/EDS, Precise/MFS, Precise/MQX, Precise/MQX Test Suites, Precise/RTCS, RTCS, SeeCode, TotalCore, Turbo186, Turbo86, V8 µ RISC, V8 microRISC, and VAutomation are trademarks of ARC International. High C and MetaWare are registered under ARC International. The PowerPC name is a trademark of IBM Corp. and is used under license. The described product contains a PowerPC processor core. The PowerPC name is a trademark of IBM Corp. and used under license. The described product is a PowerPC microprocessor. The PowerPC name is a trademark of IBM Corp. and is used under license. The described product is a PowerPC microprocessor core. The PowerPC name is a trademark of IBM Corp. and is used under license. All other product or service names are the property of their respective owners.

© 1994-2008 ARC™ International. All rights reserved.

© Freescale Semiconductor, Inc. 2009. All rights reserved.

Document Number: TSSEGTUG

Rev. 1

07/2009

Revision History

To provide the most up-to-date information, the revision of our documents on the World Wide Web will be the most current. Your printed copy may be an earlier revision. To verify you have the latest information available, refer to:

<http://www.freescale.com>

The following revision history table summarizes changes contained in this document.

Revision Number	Revision Date	Description of Changes
Rev. 1	07/2009	Launch Release.

Freescale™ and the Freescale logo are trademarks of Freescale Semiconductor, Inc.
 © Freescale Semiconductor, Inc., 2009. All rights reserved.

Chapter 1

Before You Begin

1.1	About This Book	1-1
1.2	Reference Material	1-1
1.3	Conventions	1-2
1.4	Acronyms and Abbreviations	1-2

Chapter 2

System Overview

2.1	Introduction	2-1
-----	--------------------	-----

Chapter 3

Electrode Graphing Tool Setup

3.1	Overview	3-1
3.2	Electrode Graphing Tool Requirements	3-1
3.3	Electrode Graphing Tool Installation	3-1
3.4	DEMOJM Driver Installation	3-4

Chapter 4

DEMOJM Setup

4.1	Hardware Setup	4-1
4.1.1	IIC Module	4-1
4.1.2	Power	4-2
4.1.3	Mini USB	4-2
4.1.4	Application Setup	4-3
4.1.5	Initialization Function	4-5
4.1.6	Main Function	4-6

Chapter 5

Using the EGT Software

5.1	Launch EGT	5-1
5.2	Electrode Graphing Tool	5-2
5.2.1	EGT Graphs	5-2
5.2.1.1	Control Graph	5-2
5.2.1.2	Electrode Legend	5-3
5.2.1.3	Selector Section	5-4
5.2.1.4	Plot Delta	5-4

5.2.1.5 Zoom	5-5
5.2.1.6 Refresh Rate	5-7
5.2.1.7 Data Logger	5-8
5.2.1.8 Control Buttons	5-9
5.2.1.9 Values	5-10
5.2.2 Config	5-11

Chapter 6

Troubleshooting

6.1 Microsoft .NET Framework	6-1
6.2 Device Connected Before Installation	6-1
6.3 Multiple Driver Installation	6-1
6.4 Device Connected Before Launch	6-1

Chapter 1

Before You Begin

1.1 About This Book

This guide describes how to use the Touch Sensing Software Electrode Graphing Tool (TSSEGT). The TSSEGT allows you to visualize the capacitance variance of electrodes when it is used along with the Touch Sensing Software (TSS).

For more information on using the Touch Sense Software, refer to the Freescale Proximity website at www.freescale.com.

This document is intended for software, hardware, and system engineers who are developing their products or software applications using Touch Sensing Library to integrate capacitive sensing.

Table 1-1 shows the summary of chapters included in this guide.

Table 1-1. TSSEGTUG Summary

Chapter Title	Description
Before You Begin	This chapter provides the prerequisites of reading this book.
Introduction	This chapter provides an introduction for the Electrode Graphing Tool (EGT).
Electrode Graphing Tool Setup	This chapter provides information about the installation process and requirements needed for the use of the EGT.
DEMOJM Setup	This chapter explains the configuration and setup of the DEMOJM board.
Using the EGT Software	This chapter explains all the functions of the EGT.
Troubleshooting	This chapter provides guidelines to the most frequent errors when using the EGT.

1.2 Reference Material

Use this book in conjunction with:

- *Touch Sensing Software Users Guide* (document TSSUG)
- *Touch Sensing Software API Reference Manual* (document TSSAPIRM)
- *Touch Sensing Software EVB Users Guide* (document TSSEVBUG)

For better understanding, refer to the following documents.

- Application note titled *Designing Proximity Sensing Electrodes* (document AN3863)
- Application note titled *Touch Panel Applications Using the MC34940/MC33794 E-Field IC* (document AN1985)
- CodeWarrior Help

You can download the latest version of the documents at Freescale website, www.freescale.com.

1.3 Conventions

This guide uses the following notations:

- Courier monospaced type indicates commands, command parameters, code examples, expressions, datatypes, and directives.
- Italic type indicates replaceable command parameters.
- All source code examples are in C.

1.4 Acronyms and Abbreviations

EGT	Electrode Graphing Tool
GPIO	General-Purpose Input/Output
MCU	Microcontroller Unit
PC	Personal Computer
TSS	Touch Sensing Software
TSSEVB	Touch Sensing Software Evaluation Board

Chapter 2 System Overview

2.1 Introduction

The Electro Graphing Tool (EGT) is a graphic user interface created to work with the TSS. EGT allows you to calibrate your TSS application for every electrode used in the system. EGT shows the behavior in real time of all the electrodes present in the system.

EGT uses a DEMOJM that serves as a bridge between the PC and the application. The DEMOJM board communicates with the application through IIC protocol and with the PC using USB protocol.

The DEMOJM board must be previously loaded with the EGT Communication firmware. The firmware can be downloaded from the Freescale web site at www.freescale.com.

Figure 2-1 shows the modules needed to use the EGT.

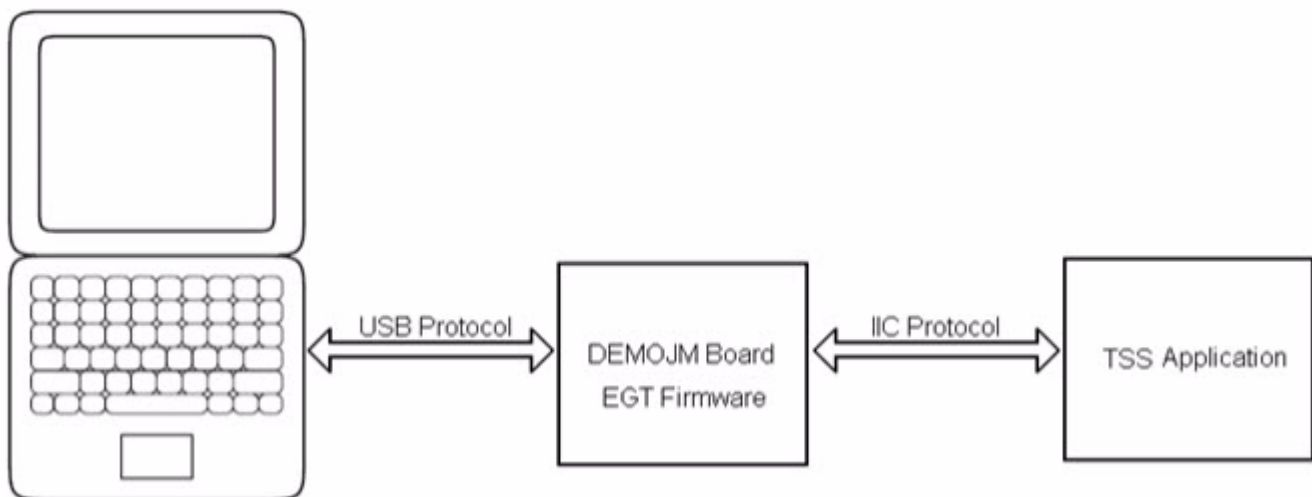

Figure 2-1. TSS and EGT Communication System

Chapter 3

Electrode Graphing Tool Setup

3.1 Overview

This chapter describes the EGT installation process and the driver installation for the DEMOJM board.

3.2 Electrode Graphing Tool Requirements

To use EGT, you need to meet the following requirements:

1. Install Microsoft .NET Framework 2.0 or higher (installation will notify you if you have already installed it). You can get Microsoft .NET Framework on the Microsoft web site at www.microsoft.com/downloads/.
2. A DEMOJM board with the EGT communication firmware. The DEMOJM board serves as a bridge between the application's MCU and the PC. You can download the EGT communication firmware on the Freescale web site at www.freescale.com.
3. A Freescale MCU (any S08) and a properly designed hardware for electrodes (Freescale's TSSEVB board recommended). For more details on the electrode hardware needed to test the TSS, refer to TSSEVB board documentation.

NOTE

EGT must be installed before plugging the DEMOJM board in the system. When you first plug a board in the system, the system will prompt you to install drivers. If this occurs, do not allow Windows to automatically search for and install the drivers.

3.3 Electrode Graphing Tool Installation

This section describes the EGT installation process.

To install EGT, perform the following steps:

1. Get the latest version of EGT on the Freescale web site at www.freescale.com.
2. Unzip the EGTInstaller.zip file to a local folder in your computer.
3. Launch the Electrode Graphing Tool installer EGTInstaller.msi. The wizard installer window appears. Click Next to begin the installation process.

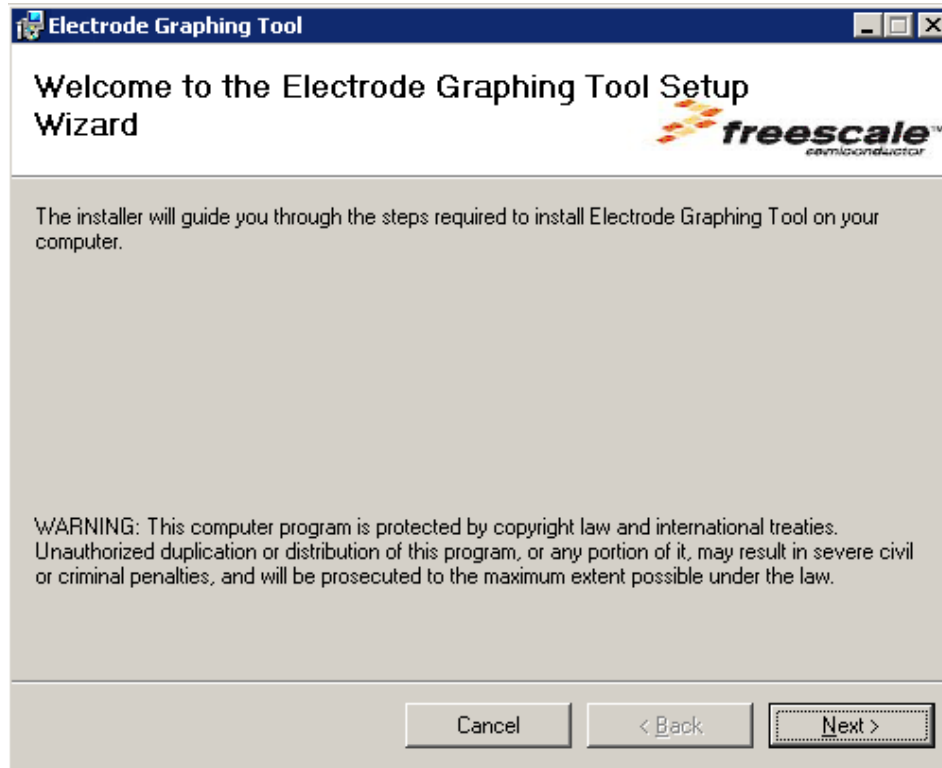

Figure 3-1. Wizard Installer Window

4. The Select Installation Folder window, as shown in [Figure 3-2](#), will appear. Choose a destination folder or leave the default destination path. Select if application will be available for all users on the computer or only for the current user (administrator privileges are needed to make an installation for all users). The Disk Cost button shows the free space on your local drive and gives information about how much disk space the application will require. Click Next to continue.

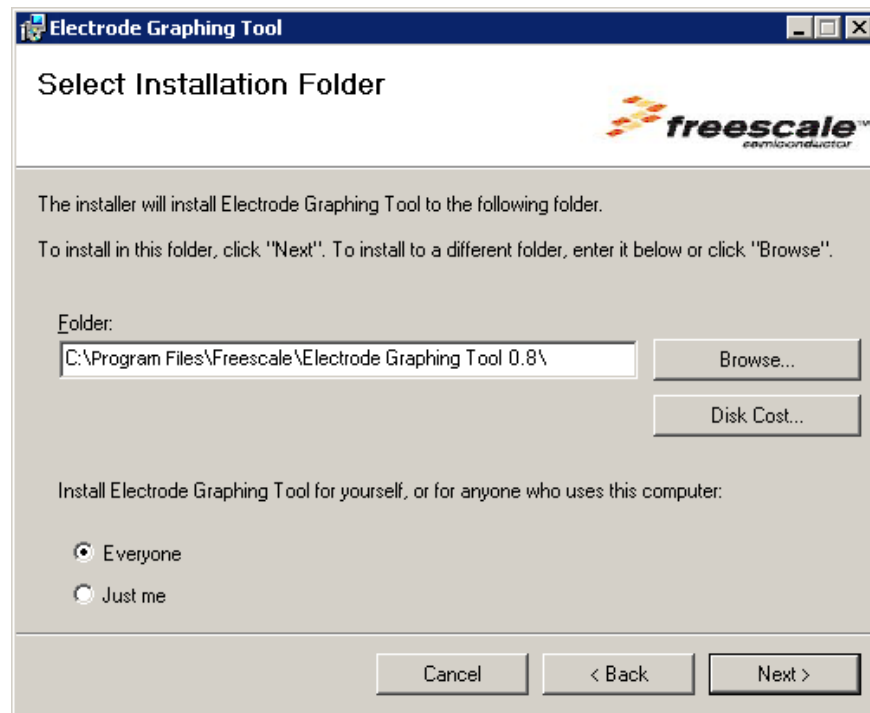

Figure 3-2. Select Installation Folder Window

5. The Confirm Installation window will appear. Click Next to start copying the files into your computer. A window indicating the installation progress will appear. After installation, a window indicating that the installation is completed will appear. Click the Close button.

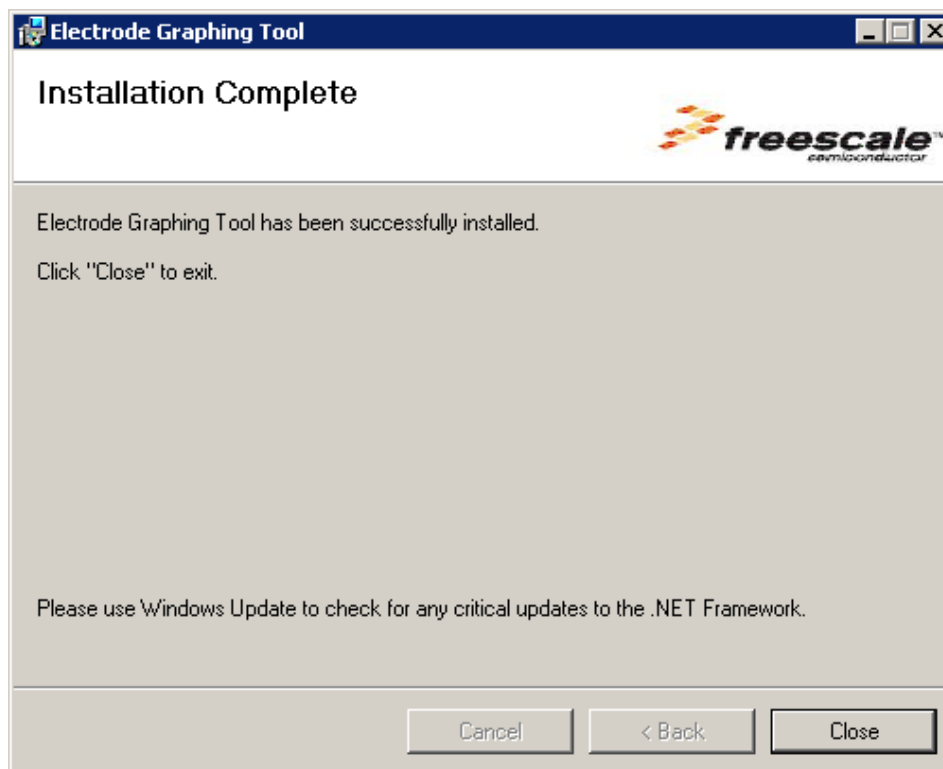

Figure 3-3. Confirm Installation Window

3.4 DEMOJM Driver Installation

EGT needs a DEMOJM board with the EGT Communication firmware that serves as a bridge between the PC and the application. To start communication between the DEMOJM board and the PC, install the appropriate driver on the PC.

Install EGT before plugging the DEMOJM board into your PC.

This section describes the installation of the driver of the DEMOJM board.

1. Plug the DEMOJM board into the USB port of your computer. The New Hardware Wizard will appear. Check the **Install from a list of specific location (Advanced)** option and click Next.



Figure 3-4. New Hardware Wizard

- The system will prompt you to choose the path where the driver is located. Select the **Include this location in the search** checkbox, and click the Browse button.

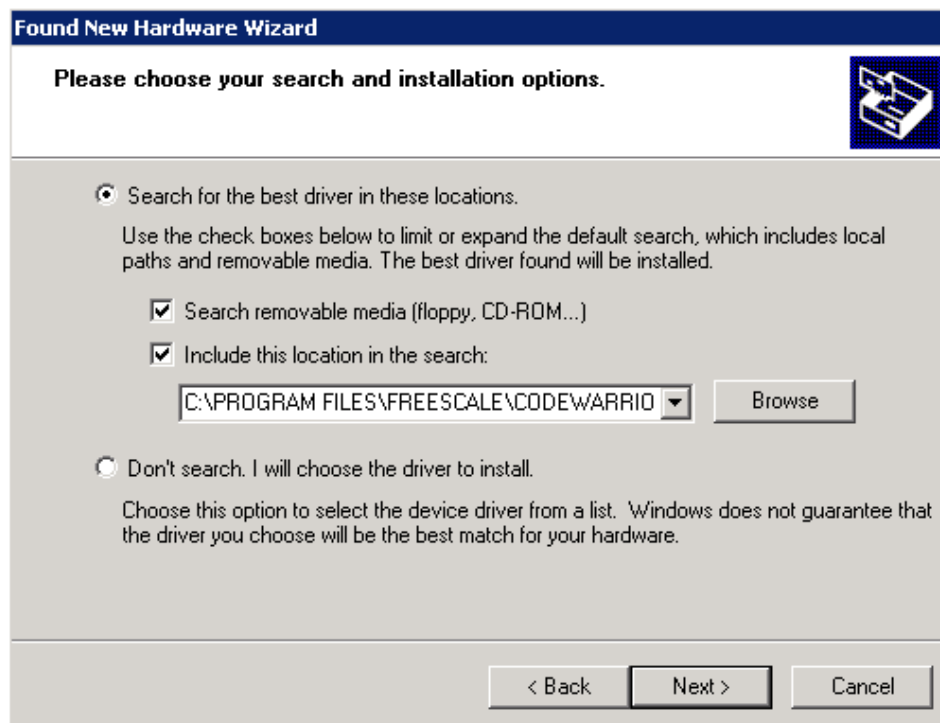

Figure 3-5. Driver Path Window

3. The **Browse For Folder** window will appear. Navigate to the driver location. The DEMOJM Board driver is included with the EGTInstaller. The driver resides in the installation folder `c:\Program Files\Freescale\Electrode Graphing Tool\Driver`. After finding the folder, click the OK button.

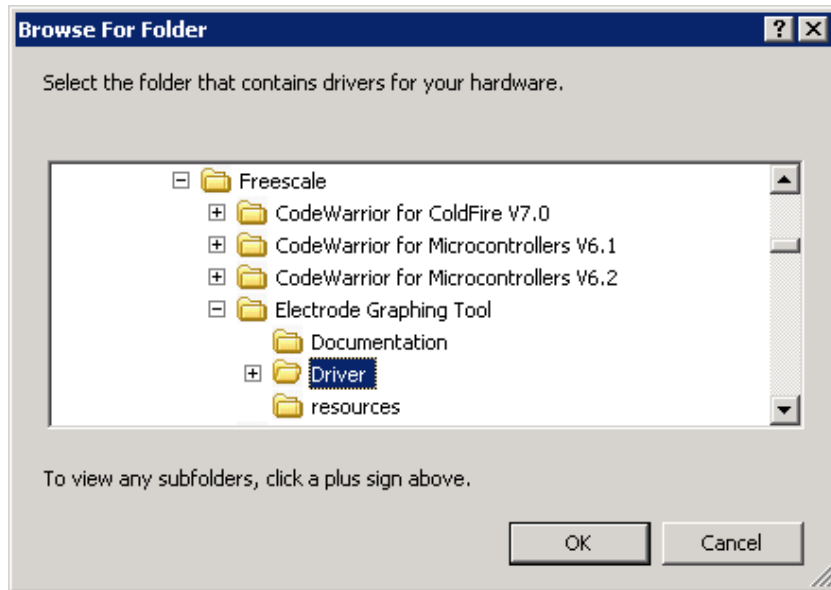

Figure 3-6. Browse For Folder Window

4. The window will be closed. Once the driver path has been set, click on the Next button.

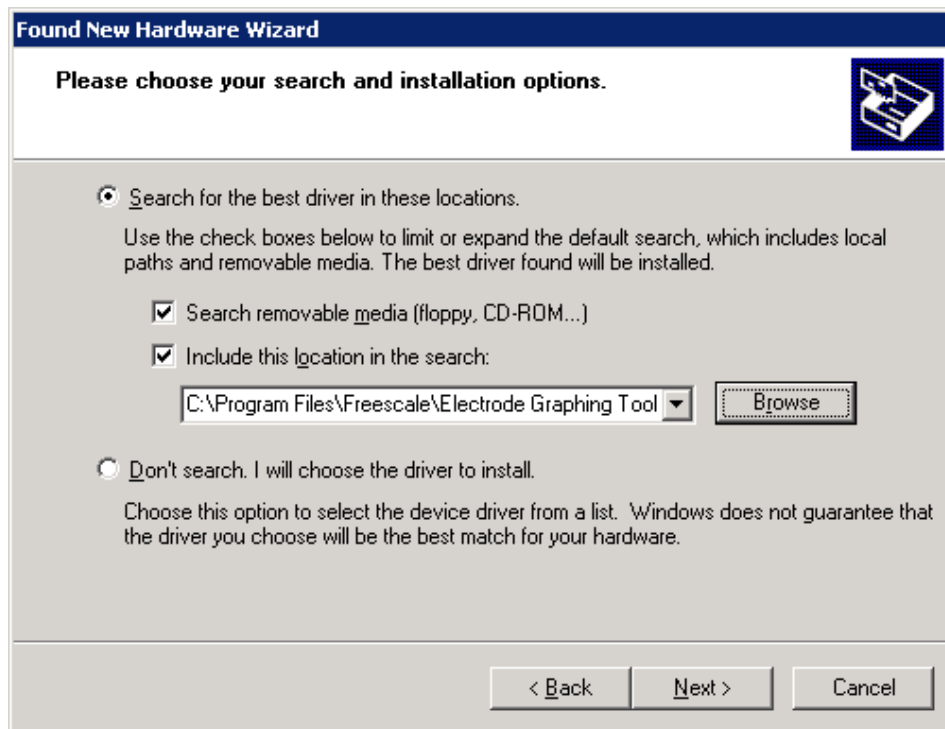

Figure 3-7. Driver Path Window

- Windows will start installing the driver.

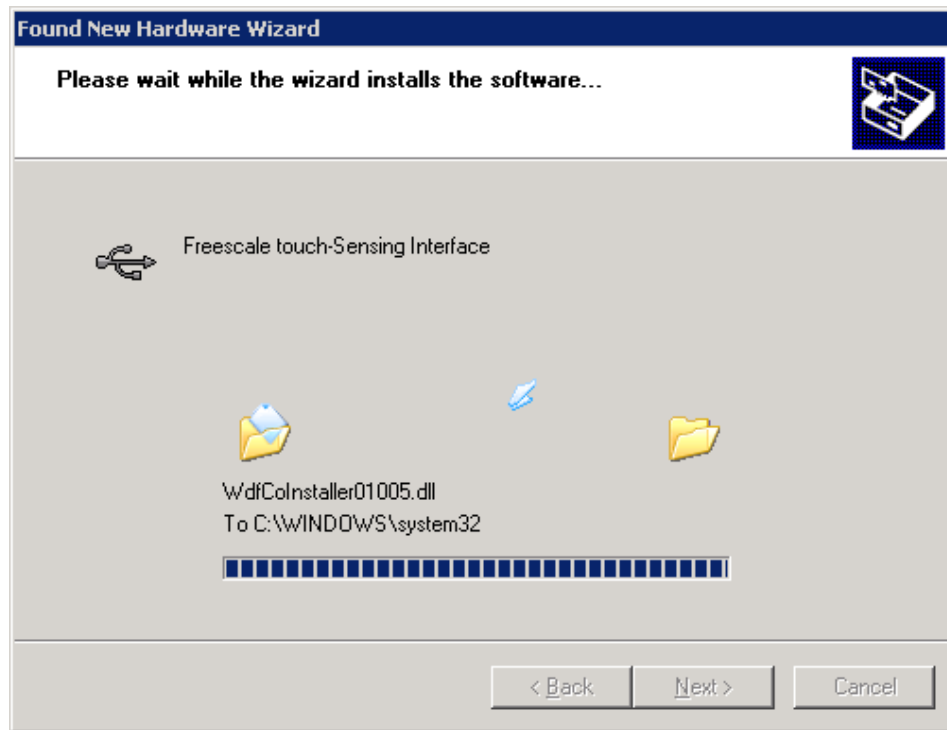

Figure 3-8. Driver Installation

- After the installation, a window will notify you of the successful installation. Click the Finish button. The DEMOJM driver is now installed.

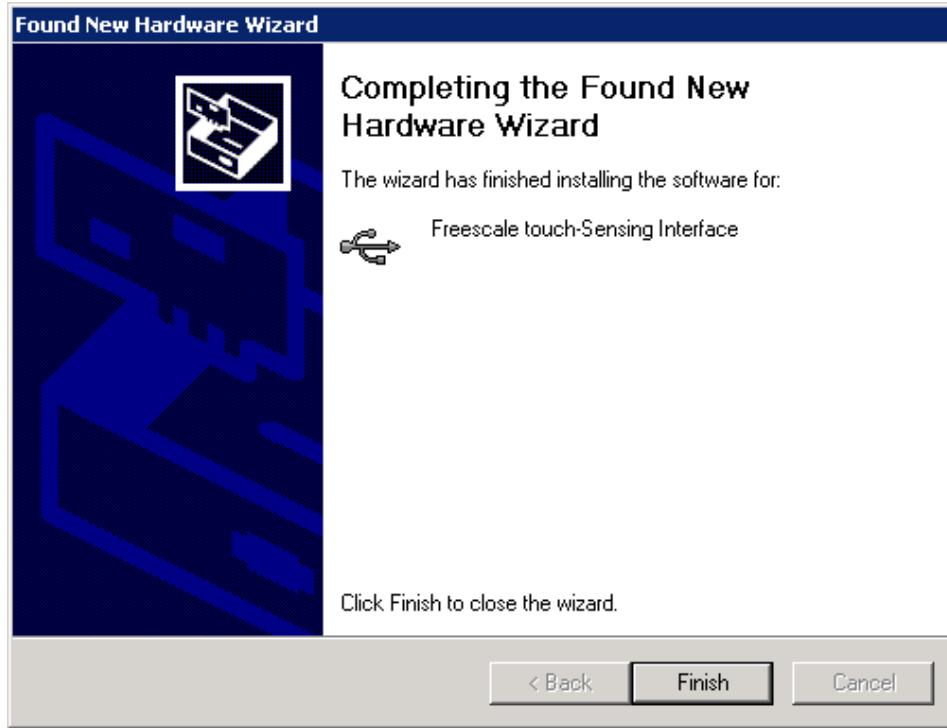

Figure 3-9. Driver Installation Complete

Chapter 4

DEMOJM Setup

You must correctly configure the DEMOJM board to ensure the correct operation of EGT. This section chapter describes the configuration process of the DEMOJM board. If you are using another communication board, refer to the appropriate documentation.

4.1 Hardware Setup

4.1.1 IIC Module

Connect the DEMOJM board to your TSS application. The DEMOJM board and the application's MCU communicate with each other using the IIC module. To locate the IIC pins from the MCU used on your application, refer to the MCU's Reference Manual. On the DEMOJM board, the IIC pins are located in the number 26 (SCL) and 28 (SDA) of the MCU Port. [Figure 4-1](#) shows the pinout for the MCU Port connector on the DEMOJM board. For more information regarding the DEMOJM board, refer to the *DEMOJM User Manual* (document DEMOJMUM).

VDD	1	2	IRQ/TPMCLK
VSS	3	4	RESET
PTE0/TxD1	5	6	BKGD/MS
PTE1/RxD1	7	8	VUSB33
PTG0/KBIP0	9	10	PTB0/MISO2/ADP0
PTG1/KBIP1	11	12	PTB1/MOSI2/ADP1
PTE2/TPM1CH0	13	14	PTB2/SPSCK2/ADP2
PTE3/TPM1CH1	15	16	PTB3/SS2/ADP3
PTE5/MOSI1	17	18	PTB4/KBIP4/ADP4
PTE4/MISO1	19	20	PTB5/KBIP5/ADP5
PTE6/SPSCK1	21	22	PTB6/ADP6
PTE7/SS1	23	24	PTB7/ADP7
PTF0/TPM1CH2	25	26	PTC0/SCL
PTF1/TPM1CH3	27	28	PTC1/SDA
PTF2/TPM1CH4	29	30	PTG2/KBIP6
PTF3/TPM1CH5	31	32	PTG3/KBIP7_J1
VREFH	33	34	PTF4/TPM2CH0
VREFL	35	36	PTF5/TPM2CH1
PTD0/ADP8/ACMP+	37	38	PTC5/RxD2
PTD1/ADP9/ACMP-	39	40	PTC3/TxD2
PTD2/KBIP2/ACMPO4	41	42	PTG4/XTAL
PTD3/KBIP3/ADP10	43	44	PTG5/EXTAL
PTD4/ADP11	45	46	PTA0
PTD5	47	48	PTA1
PTD6	49	50	PTA2
PTD7	51	52	PTA3
PTC2	53	54	PTA4
PTC4	55	56	PTA5
PTC6	57	58	PTF6
NC	59	60	PTF7

Figure 4-1. DEMOJM MCU Port

4.1.2 Power

Power the DEMOJM board using the same power supply that the TSS application is using to power the MCU. You can connect the power supply to the DEMOJM MCU port as shown in [Figure 4-1](#). If you are using any other communication board, refer to the board documentation to ensure that no other power source is enabled in the board.

4.1.3 Mini USB

Connect the PC to the DEMOJM board using a USB cable.

To connect the PC to the DEMOJM board:

1. Connect one side of the cable to the Mini USB port located on the DEMOJM.

2. Connect the other side of the cable to any free USB port of the computer.

NOTE

In case the driver has not been installed, follow the instructions presented in the section 2.3.

4.1.4 Application Setup

You must add the files that allow the application communicate with the DEMOJM board through IIC protocol. In addition, add a couple of instructions to your application code. This section will guide through the setup and configuration of the EGT communication module.

Adding the EGT Communication Files

1. Select **Start > Programs > Freescale CodeWarrior > CodeWarrior > CodeWarrior** for HC(s)08 Development Studio.
2. From the CodeWarrior IDE menu bar, select **File > Open**.
3. On the Open File dialog box, find the project file (*.mcp) and click on the Open button. The IDE opens the Project.mcp as shown in the following figure.

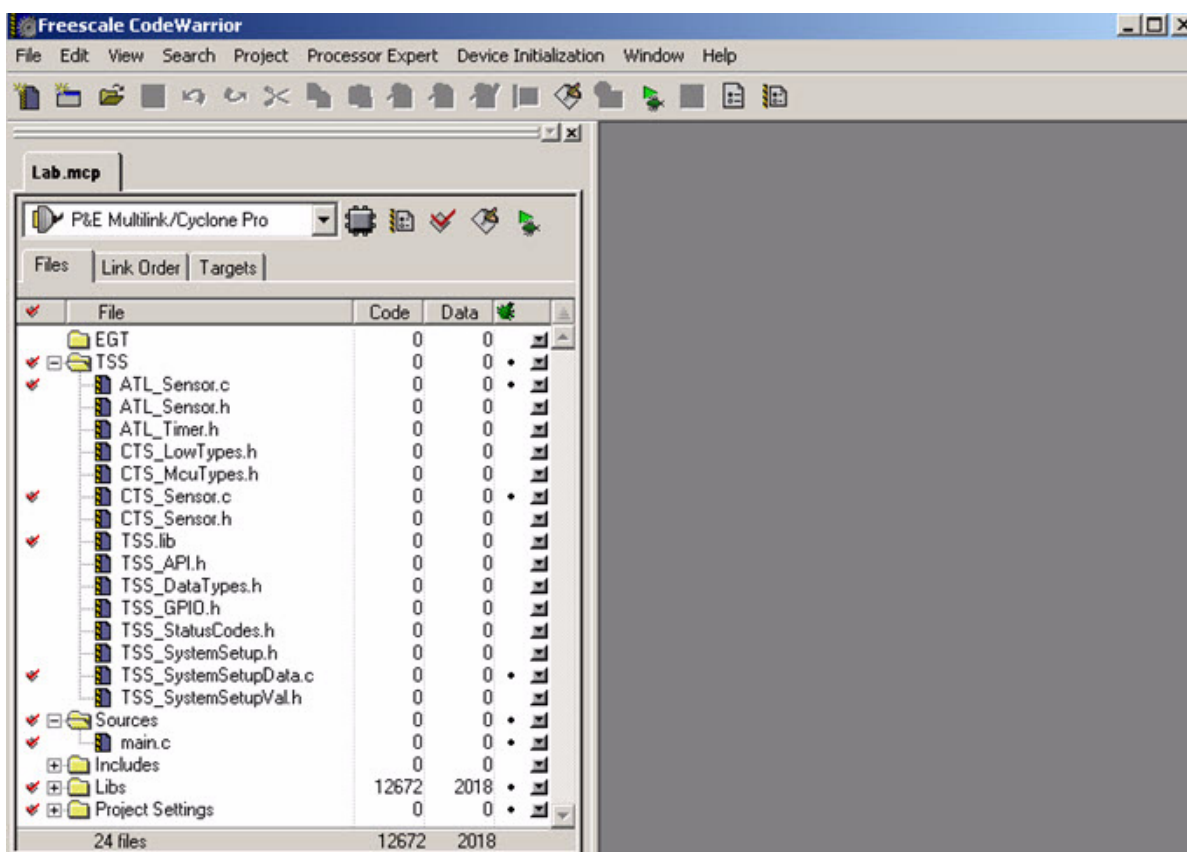

Figure 4-2. Existing Project Structure

- When adding the EGT communication files to an existing project, create a group to store the TSS files together. From the CodeWarrior main menu, select **Project > Create Group**. The create group window appears. Enter a name for the group and click the Ok button.

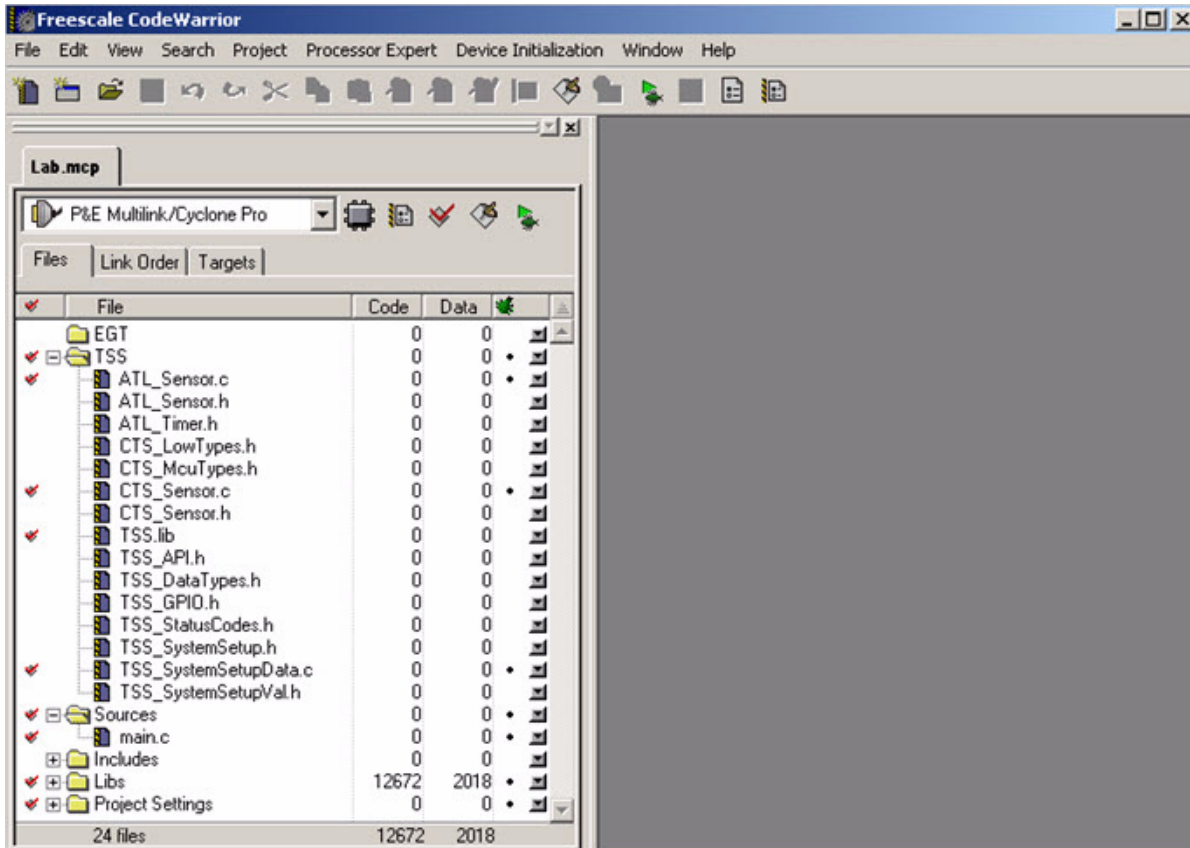

Figure 4-3. Creating a Group

- On the project window, click the group created to select this item. From the CodeWarrior main menu bar, select **Project > Add Files**. The Open File dialog box appears. Find the EGT Communication files, select all the files, and click the Open button. CodeWarrior adds the files into the group created.

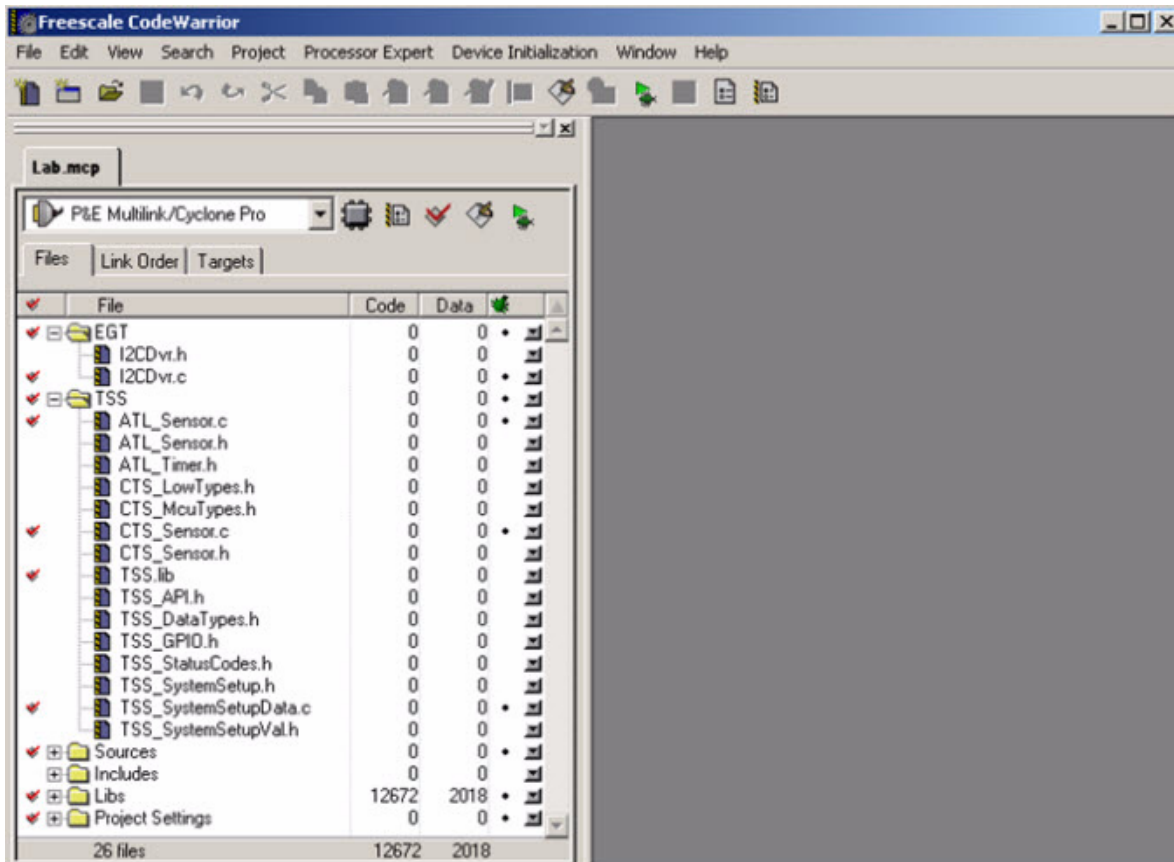

Figure 4-4. Adding Files to the Group

6. Add the following files:

- I2CDvr.c
- I2CDvr.h

NOTE

Before adding the TSS files to an existing project, make a copy of the TSS files and paste them on the folder where the existing project is saved. This way, the files are better organized and the modification of the original TSS files is avoided. The TSS files should be copied to the `c:\...Project\Source` folder. Project indicates the name of an existing project where the TSS files are added.

4.1.5 Initialization Function

The EGT communication module must be initialized.

To initialize the EGT communication module, perform the following steps:

1. Include the `I2CDvr.h` header file into the `main.c` file of the TSS application.

```

#include <hidef.h>          /* for EnableInterrupts macro */
#include "derivative.h"    /* include peripheral declarations */
#include "TSS_API.h"      /* Include Touch Sense Software header file */
#include "I2CDvr.h"       /* Electrode Graphing Tool Communication header file */
    
```

Figure 4-5. main.c File Definition

2. Call the `I2CInit()` to initialize the EGT Communication module. Add the initialization function into the initialization section of the application.

```

void main(void) {
    MCU_Init();           /* Initializes MCU Peripherals */
    void TSS_Init();     /* Initializes the Touch Sense Library */
    I2CInit();           /* EGT module Initialization */
}
    
```

Figure 4-6. Communication Module Initialization

There are some MCUs that have more than one assigned pin for each IIC signal. Correctly configure the IIC pin signals in the application MCU.

4.1.6 Main Function

The EGT module includes a main task that must constantly be called by the user application like the TSS main task.

Add the EGT module main task `EGTTask()` to the main loop of your application.

```

EnableInterrupts;       /* Enable interrupts */
for(;;) {
    TSS_Task();         /* TSS main function */
    EGTTask();         /* EGT Communication Module main function */
    __RESET_WATCHDOG(); /* feeds the dog */
} /* loop forever */
/* please make sure that you never leave main */
    
```

Figure 4-7. Communication Module Main function

Chapter 5

Using the EGT Software

This chapter describes how to launch and use EGT.

5.1 Launch EGT

To launch EGT, perform the following steps:

1. Connect the DEMOJM board to your application board through the IIC module.
2. Connect the DEMOJM board to the PC through the USB cable.
3. To start EGT, select **Start > Programs > Freescale > Electrode Graphing Tool > Electrode Graphing Tool**.

EGT requires no further configuration since it automatically detects the electrodes present in the system. EGT should start the electrode measurements as soon as it is launched.

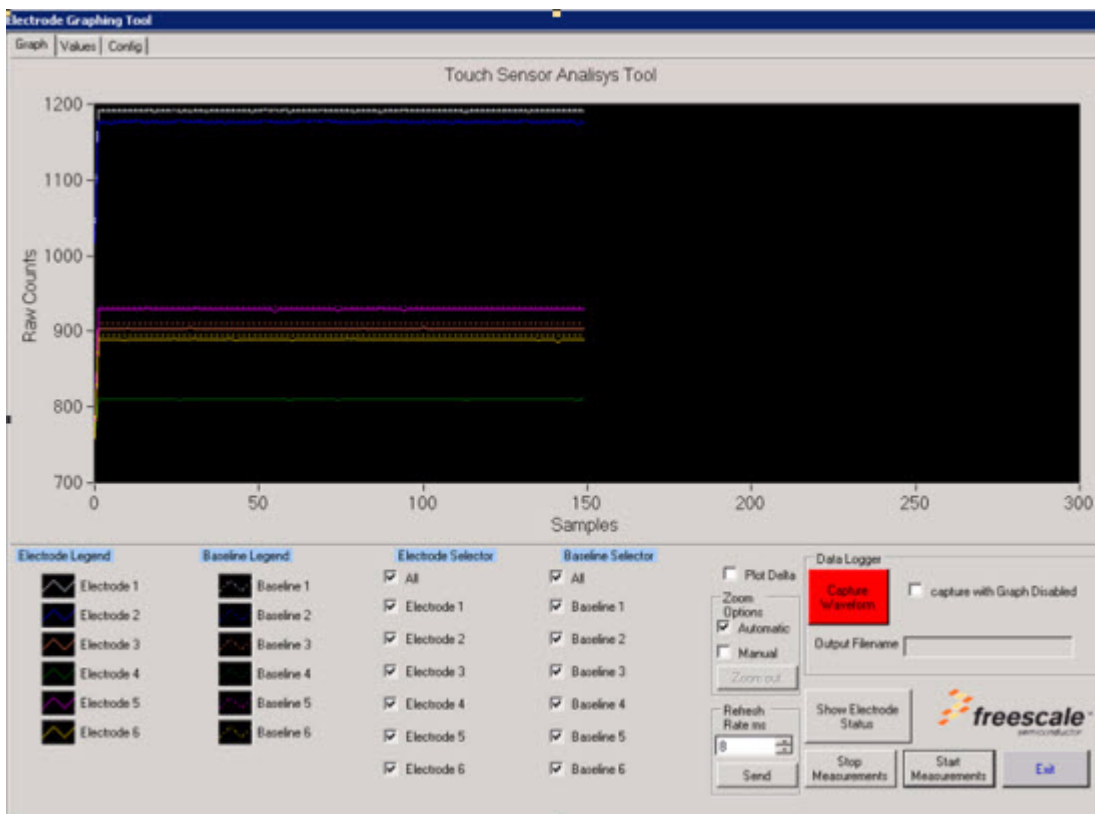

Figure 5-1. Electrode Graphing Tool Main Window

5.2 Electrode Graphing Tool

This section describes the features of EGT.

EGT features the following windows:

- Graph
- Values
- Config

You can change between windows by clicking the tabs located at the top of the EGT window. [Figure 5-2](#) shows the tabs that allow you to select any of the windows.

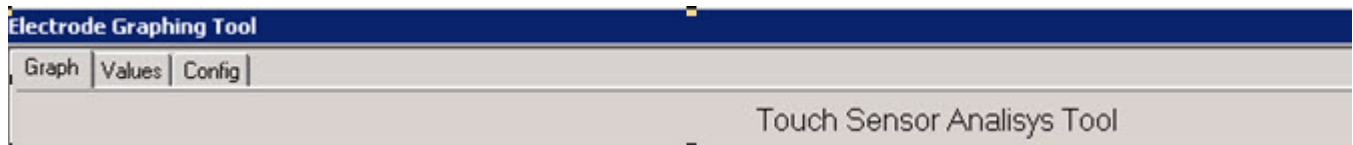

Figure 5-2. Electrode Graphing Tool Tab Selection

5.2.1 EGT Graphs

The Graph window plots the capacitance measurements and the Baseline values of each electrode.

5.2.1.1 Control Graph

This part of the Graph window plots the capacitance and baseline values. The capacitance values are plotted with a continuous line while the baselines values are plotted with a dotted line. Each electrode is represented with a different color waveform.

[Figure 5-3](#) shows the control graph.

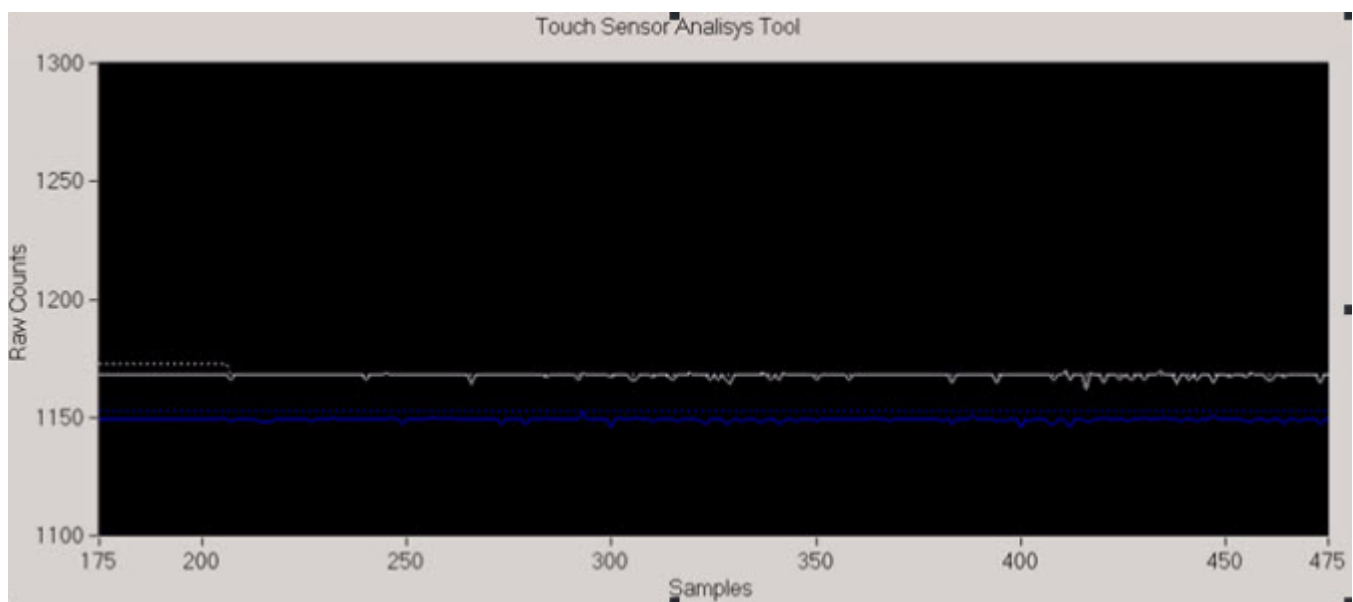

Figure 5-3. EGT Control Graph

5.2.1.2 Electrode Legend

The Electrode legend section shows the color waveform assigned to each electrode present in the application. [Figure 5-4](#) shows the Electrode Legend section.

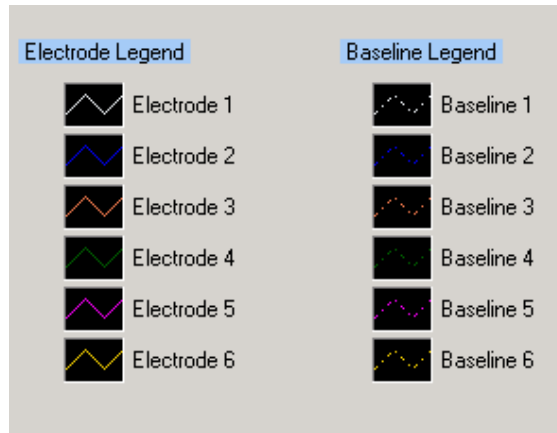

Figure 5-4. EGT Electrode Legend

EGT assigns one color for each electrode. However, you can choose the waveform color for each electrode. To change the plotting color of the waveform, perform the following steps:

1. Double-click any of the Electrodes Legends. The Change Color dialog box appears.
2. On the Change Color dialog box, provide the number of electrode you wish to change color and click the OK button.

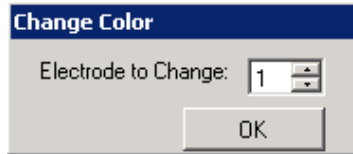

Figure 5-5. Electrode Selection

3. A color selector dialog box ([Figure 5-6](#)) appears. Choose the new color for the waveform, and click the OK button. The waveform color will change.



Figure 5-6. Color Palette

5.2.1.3 Selector Section

In the selector section, you can select the electrodes and baselines you wish to plot. By default, EGT plots all the capacitance values and baseline values for all the electrodes present in the application. [Figure 5-7](#) shows the Selector section.

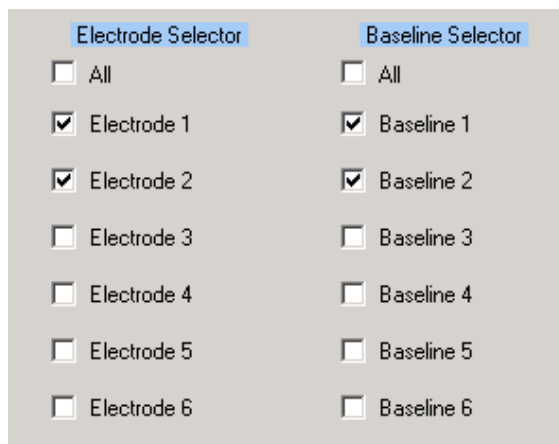

Figure 5-7. Electrode and Baseline Selector

You can enable or disable all the electrodes capacitance waveforms at once by clicking the All checkbox. The same applies to the baseline waveforms.

5.2.1.4 Plot Delta

EGT allows you to choose between plotting the capacitance measurements along with its respective baseline value or plotting the delta values. The delta value is the difference between the baseline value and

the capacitance value. To plot the delta values, click the Plot Delta checkbox. [Figure 5-8](#) shows the Plot Delta checkbox.

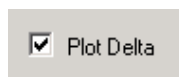

Figure 5-8. Plot Delta Option

5.2.1.5 Zoom

EGT features a zoom option so that you can observe in detail the capacitance and baseline waveforms. [Figure 5-9](#) shows the zoom section.

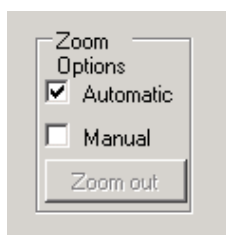

Figure 5-9. EGT Zoom Control

By default, EGT starts with the automatic zoom. When the automatic zoom is selected, EGT automatically sets the limits on the vertical axis of the control graph. The limits are based on the capacitance values that the TSS is detecting on the electrodes. This way the zoom is adjusted so that you can see all the capacitance waveforms.

When the Manual zoom option is selected, EGT sets arbitrary limits to the vertical axis that may or may not show all the capacitance measurement waveforms. In the Manual Zoom option, you can establish the vertical axis limits. To establish the axis limits, perform the following steps:

1. Select the Manual Zoom option by clicking the Manual check box.
2. Click the lowest and highest values of the vertical axis and assign the new limit values.

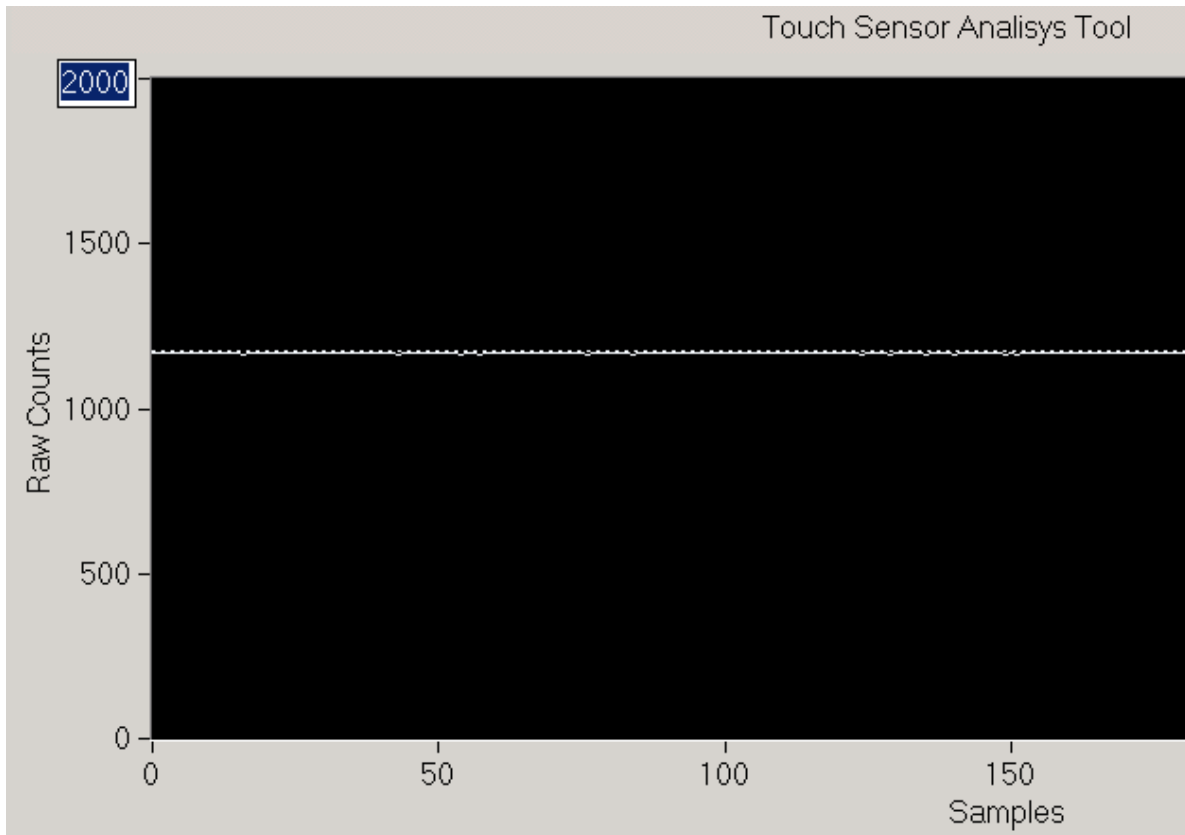

Figure 5-10. EGT Control Graph Vertical Limits

The Zoom option also allows you to zoom in a captured waveform. To do so, perform the following steps:

1. Select the manual zoom option.
2. Click the Stop Measurements button.
3. In the Control graph section, click and drag to select the part of the waveform you wish to zoom in.

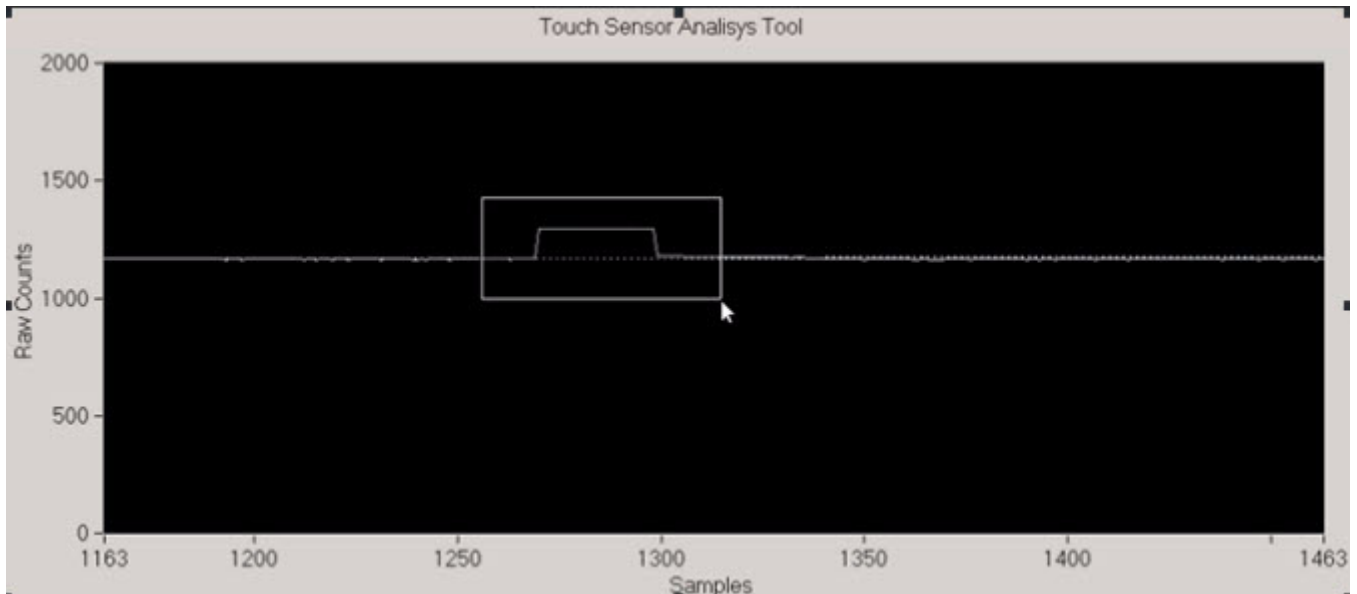

Figure 5-11. EGT Control Graph Manual Zoom

4. As soon as you select the zoom in area, EGT will perform the zoom.

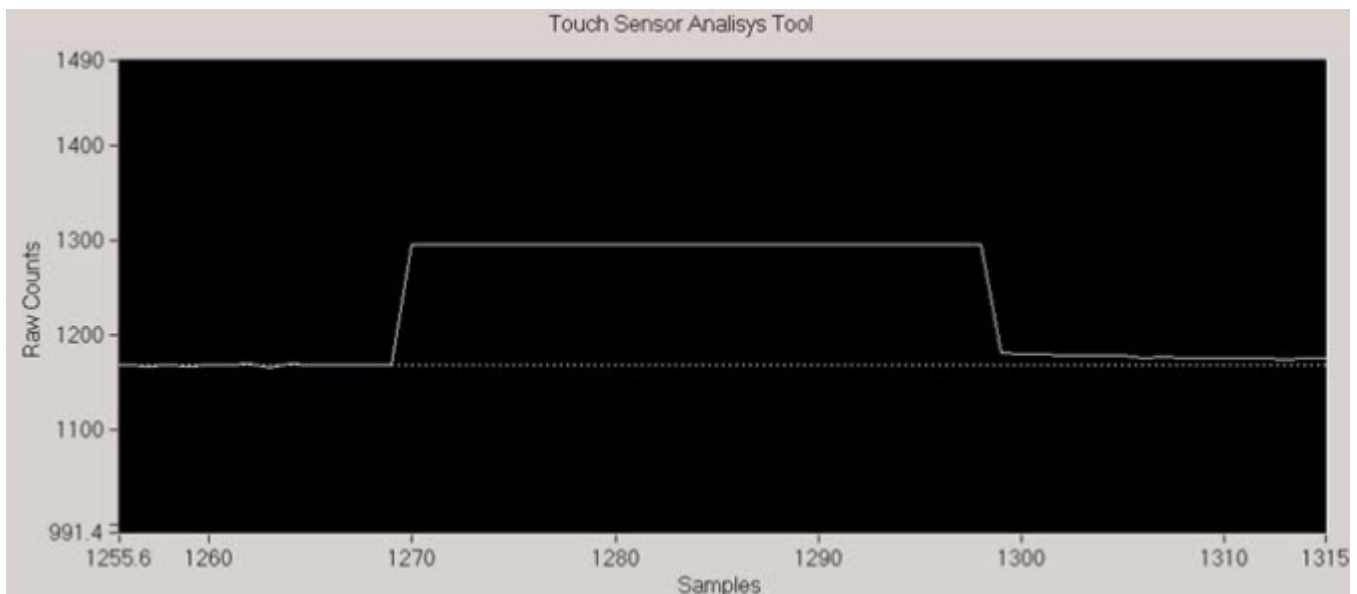

Figure 5-12. EGT Zoom Selected Area

5. To restore the zoom function, click the Zoom Out button.

5.2.1.6 Refresh Rate

EGT allows you to select the speed of the data refresh from the TSS application. To do so, perform the following steps:

1. From the Refresh Rate section, select the desired refresh time rate. The minimum allowed value is 3 ms.

2. Click the Send button. [Figure 5-13](#) shows the Refresh Rate section. EGT sets the refresh rate value to 8ms as default.



Figure 5-13. EGT Refresh Rate in Milliseconds

5.2.1.7 Data Logger

EGT allows you to save a log file of the plotted values into a csv file. To save a log file, perform the following steps:

1. Click the Output filename textbox to set the destination path where the csv file will be saved. A save file dialog box appears.

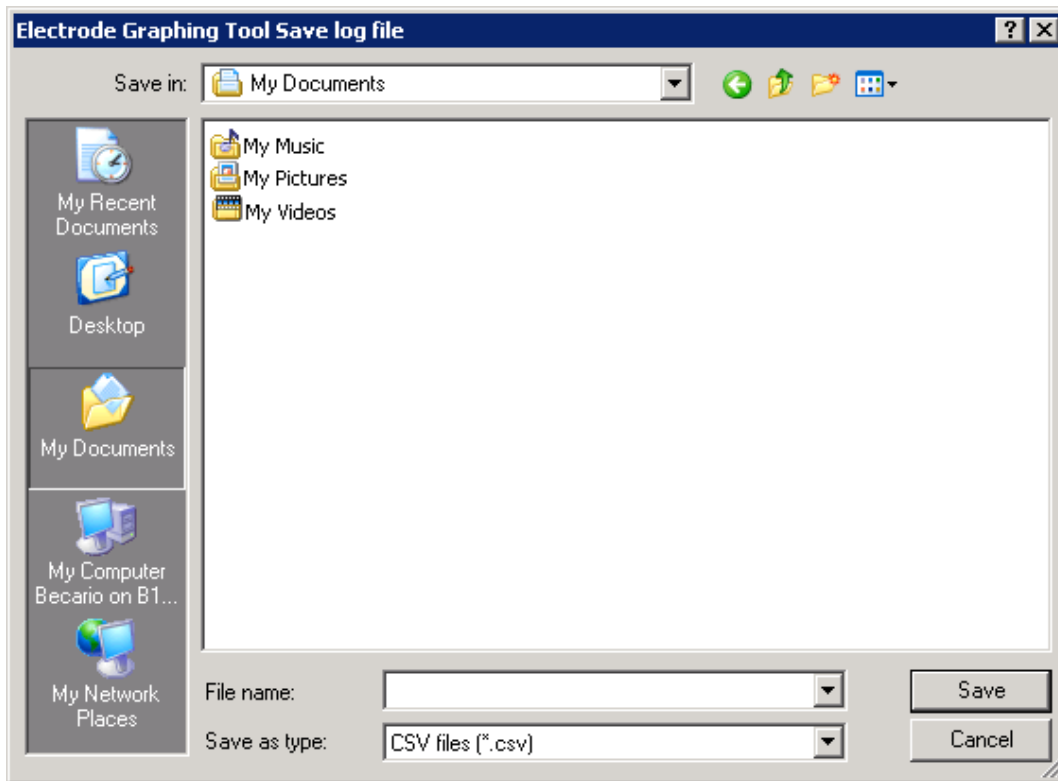

Figure 5-14. EGT Control Graph Manual Zoom

2. Choose the destination path, set a name for the csv file, and click the Save button.
3. Click the Capture Waveform button to start saving the data.

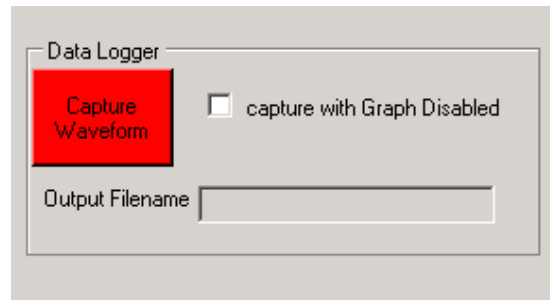

Figure 5-15. EGT Data Logger Option

4. To stop capturing, click again the Capture Waveform button. EGT will stop capturing and the file will be saved on the location specified.

If you want to capture again after you stopped, you must set the path and name of a new file. When the **capture with Graph Disable** option is selected, EGT will save the data but without showing the waveform in the Graph Control section.

5.2.1.8 Control Buttons

On the Graph window, EGT provides main control buttons that allow you to start and stop measurements and enable a feature that shows the status of the electrodes. [Figure 5-16](#) shows the control buttons section.

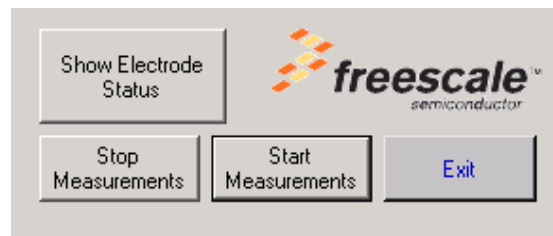

Figure 5-16. EGT Control Buttons

- **Start Measurements** — To start the measurements, click the Start Measurements button. This button is disabled if there is no communication between the bridge and the EGT application. By default, EGT starts the measurements when launched without the need of clicking the button.
- **Stop Measurements** — To Stop the measurements, click the Stop Measurements button.
- **Show Electrode Status** — When you click the show Electrode Status button, EGT will launch a window showing the status of each electrode. The Electrode Status window includes one LED for each electrode present in the system. The LED will turn on when the corresponding electrode is detected as Touched. [Figure 5-17](#) shows the Electrode Status Window.



Figure 5-17. EGT Electrode Status

5.2.1.9 Values

The Values window provides information regarding the capacitance and baselines measurements. These values are plotted on the Graph window.

Electrode Graphing Tool							
Graph		Values		Config			
Electrode Raw Counts				Electrode Baseline Counts			
E1	1168	E4	787	B1	1169	B4	790
E2	1149	E5	895	B2	1153	B5	897
E3	873	E6	865	B3	877	B6	870

Figure 5-18. EGT Values

5.2.2 Config

The Config window gives the opportunity to read the configuration registers of TSS. It also allows modification of the configuration registers in real time without the need of reloading the program on the MCU. You can modify the register values to test and debug the performance and behavior of the electrodes under different configuration parameters. The Config window also allows you to fine tune the sensibility parameters for each electrode.

To modify any value, change the value in the textbox of each parameter, and click the Write button.

You can use the Read all button to read all the parameters at once.

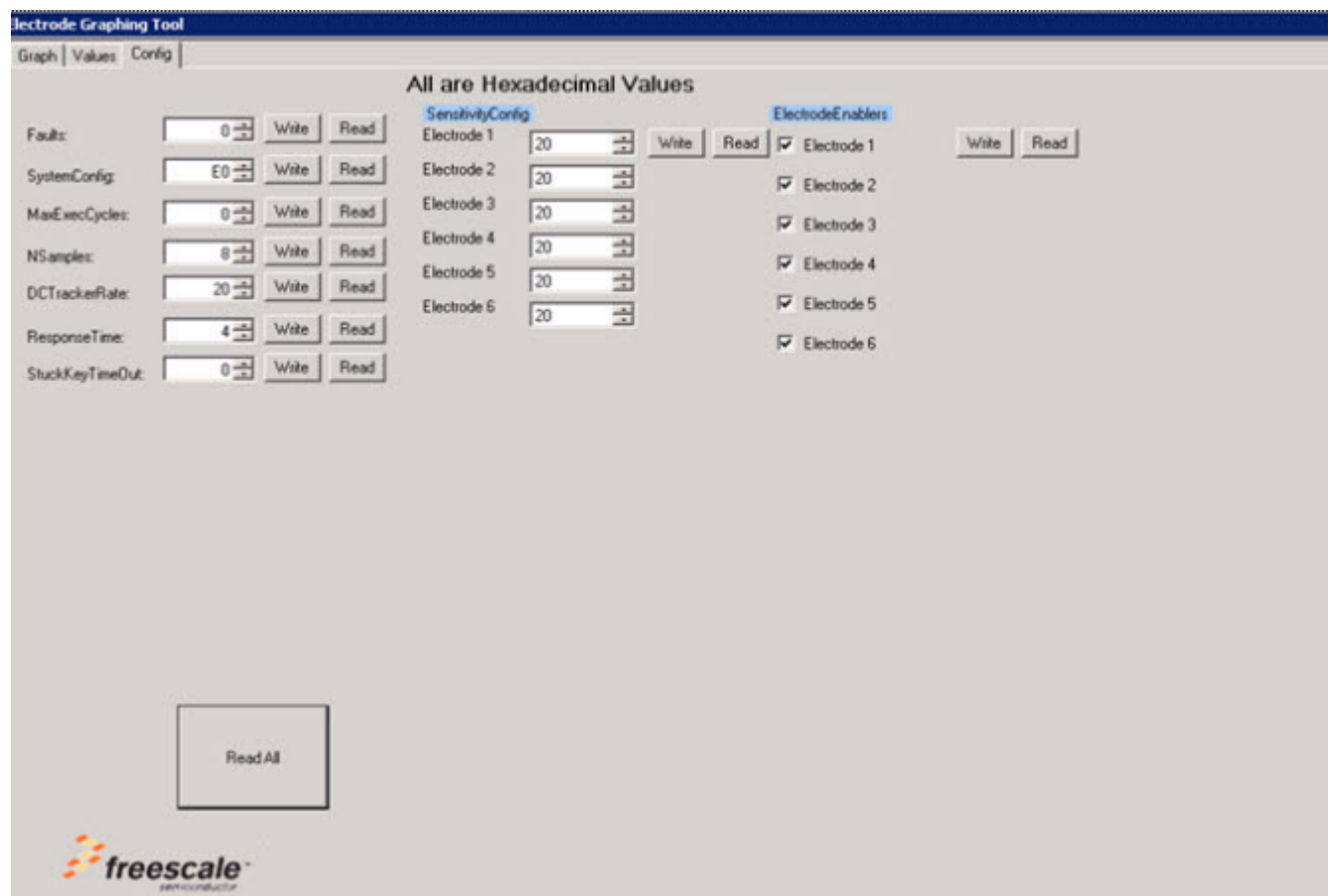

Figure 5-19. EGT Configuration Registers

Chapter 6

Troubleshooting

This chapter describes how to troubleshoot common errors when using the Electrode Graphing Tool.

6.1 Microsoft .NET Framework

To install and use EGT, you must install the .NET Framework version 2.0 or later. If you do not install the .NET Framework on your computer, the installer will help you to get it.

6.2 Device Connected Before Installation

If you connect the device before installing EGT, it is possible that the correct driver may not be present. Windows will then try to install another driver. An incorrect driver will cause the application not to communicate correctly. Uninstall the incorrect driver and install the driver. For the driver installation instructions, refer to [Chapter 2, “Electrode Graphing Tool Setup”](#) or update the driver.

6.3 Multiple Driver Installation

Every time you connect the device to a different USB port in your computer, Microsoft Windows will prompt you for driver installation. This is because when you install the driver, a virtual USB port is created.

6.4 Device Connected Before Launch

If you launch EGT before the USB is connected to computer, the application may not launch correctly. Always connect USB before to start the application.