

FRDM-KW41Z RF System Evaluation Report for BLE Applications

1. Introduction

This document provides the RF evaluation test results of the FRDM-KW41Z for BLE applications (2FSK modulation). It includes the test setup description and tools used to perform the tests on your own. To see the KW41Z radio parameters, see the *MKW41Z/31Z/21Z Data Sheet* (document [MKW41Z512](#)).

For more information about the FRDM-KW41Z Freedom Development Board, see the *FRDM-KW41Z Freedom Development Board User's Guide* (document [FRDMKW41ZUG](#)). Find the schematic and design files at this [link](#) (NXP web page).

Contents

| | | |
|------|---------------------------|----|
| 1. | Introduction | 1 |
| 1.1. | List of tests | 3 |
| 1.2. | Software | 3 |
| 1.3. | List of equipment..... | 4 |
| 2. | Tests summary..... | 5 |
| 3. | Conducted tests..... | 7 |
| 3.1. | TX tests | 7 |
| 3.2. | RX tests | 24 |
| 3.3. | Return loss..... | 37 |
| 4. | Radiated tests..... | 40 |
| 4.1. | RX test setup | 40 |
| 4.2. | RX spurious..... | 41 |
| 5. | Antenna measurements..... | 42 |
| 5.1. | Return loss..... | 42 |
| 6. | Conclusion..... | 43 |
| 7. | References | 44 |
| 8. | Revision history..... | 44 |



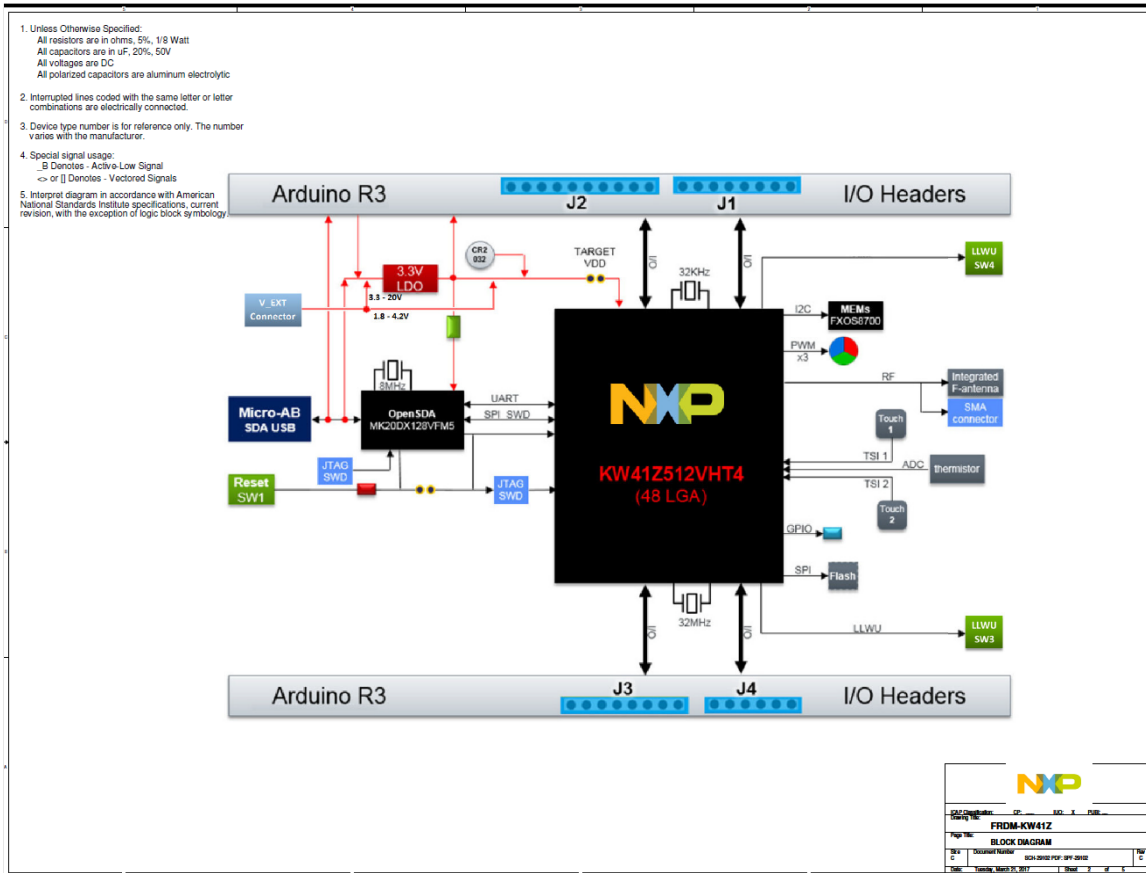

Figure 1. FRDM-KW41Z block diagram

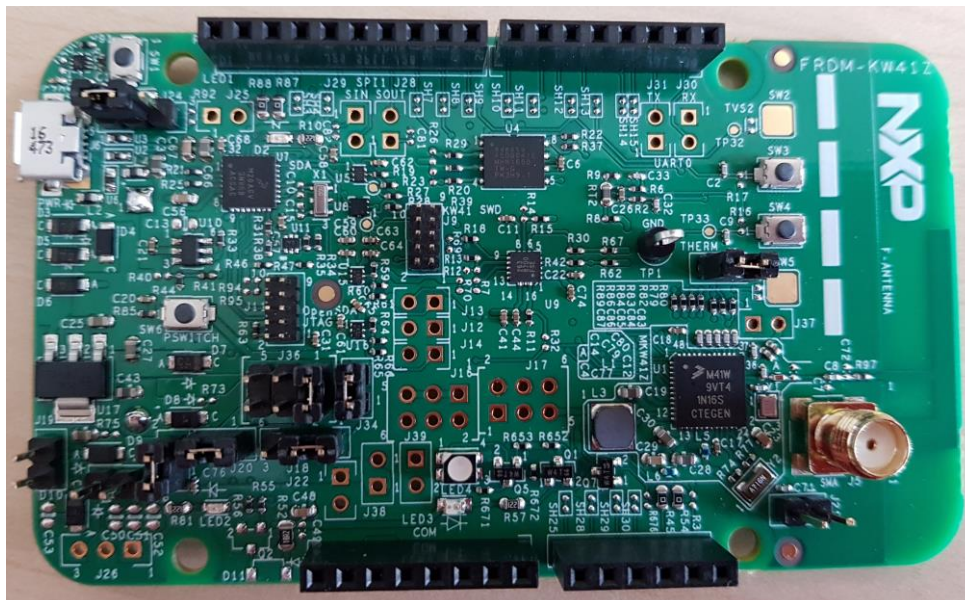

Figure 2. Freedom development kit for Kinetis/FRDM-KW41Z

1.1. List of tests

- Conducted tests
 - Tx tests
 - Bench setup
 - Frequency accuracy
 - Phase noise
 - Tx power
 - Tx power In Band
 - Tx spurious (H2 to H5, ETSI, and FCC)
 - Modulation characteristics
 - Carrier frequency offset and drift
 - Rx tests
 - Bench setup
 - Sensitivity
 - Receiver maximum input level
 - Rx spurious (from 30 MHz to 12.5 GHz)
 - Receiver interference rejection performances
 - C/I and receiver selectivity performances
 - Receiver blocking
 - Blocking interferers
 - Intermodulation
 - Return loss (S11)
 - Rx
 - Tx

1.2. Software

Before the measurements, a binary code (connectivity software) must be loaded into the board's flash memory.

The [FRDM-KW41Z: NXP® Freedom Development Kit for Kinetis® KW41Z/31Z/21Z MCUs](#) web page describes how to use the FRDM-KW41Z to load the code. The binary code that is used for the following tests is the Connectivity Software package GenFSK protocol (2FSK modulation) and the HCI_blackbox. The TERATERM terminal emulator is used to communicate with the KW41Z MCU.

1.3. List of equipment

This equipment is used to perform the RX and TX measurements:

- Spectrum Analyzer
- R&S SFU
- R&S CMW270
- MXG (Agilent N5182A)
- Agilent SML03
- Agilent 33250A
- R&S ZND Vector Network Analyzer
- RF Shielded box and RF horn
- Power supply
- PC equipped with a GPIB card

2. Tests summary

RF PHY Bluetooth® Test Specification: RF-PHY.TS.4.2.0 (2014-12-09)

The list of measurements is provided in [Table 1](#) (for Europe) and [Table 2](#) (for the US).

Table 1. List of tests (EU)

| | | EUROPE | | |
|--------------|------------------------------------|------------------|--|-----------------|
| | | <i>reference</i> | <i>limit</i> | <i>status</i> |
| Transmission | TX maximum power | BLE 4.2, BV-01-C | $-20 \text{ dBm} \leq \text{PAVG} \leq +10 \text{ dBm EIRP}$ | PASS |
| | Tx power In Band | BLE 4.2, BV-03-C | $\text{PTX} \leq -20 \text{ dBm for (fTX } \pm 2 \text{ MHz)}$ | PASS |
| | | | $\text{PTX} \leq -30 \text{ dBm for (fTX } \pm [3 + n] \text{ MHz)}$; | |
| | Modulation characteristics | BLE 4.2, BV-05-C | $225 \text{ kHz} \leq \Delta f_{1\text{avg}} \leq 275 \text{ kHz}$ | PASS |
| | Carrier frequency offset and drift | BLE 4.2, BV-06-C | $\text{fTX} - 150 \text{ kHz} \leq f_n \leq \text{fTX} + 150 \text{ kHz}$ where fTX is the nominal transmit frequency and $n = 0, 1, 2, 3 \dots k$ $ f_0 - f_n \leq 50 \text{ kHz}$ where $n = 2, 3, 4 \dots k$ | PASS |
| | Spurious 30 MHz – 1 GHz | ETSI EN 300 328 | $-36 \text{ dBm or } -54 \text{ dBm (depends on frequency)}$ (100 kHz BW) | PASS |
| | Spurious 1 GHz – 12.5 GHz | ETSI EN 300 328 | $-30 \text{ dBm (1 MHz BW)}$ | PASS |
| | Eirp Tx spectral density | ETSI EN 300 328 | 10 dBm/MHz | PASS |
| | Phase noise (unspread) | N/A | N/A | For information |

Conducted tests

| EUROPE | | |
|------------------|--------------|---------------|
| <i>reference</i> | <i>limit</i> | <i>status</i> |

| | | | | |
|------------------|---|------------------|---|------|
| Reception | RX sensitivity | BLE 4.2, BV-01-C | PER 30.8 % with a minimum of 1500 packets | PASS |
| | Co-channel | BLE 4.2, BV-03-C | > 21 dB | PASS |
| | Adjacent channel interference rejection (N +/- 1,2,3 + MHz) | BLE 4.2, BV-03-C | > 15 dB, -17 dB, -27 dB | PASS |
| | Blocking interferers | BLE 4.2, BV-04-C | -30 dBm/-35 dBm | PASS |
| | Intermodulation performance | BLE 4.2, BV-05-C | PER 30.8 % with a minimum of 1500 packets | PASS |
| | Rx maximum input level | BLE 4.2, BV-06-C | PER 30.8 % with a minimum of 1500 packets | PASS |
| | RX emissions 30 MHz – 1 GHz | ETSI EN 300 328 | -57 dBm (100 kHz) | PASS |
| | RX emissions 1 GHz – 12.5 GHz | ETSI EN 300 328 | -47 dBm (1 MHz) | PASS |

| | | | |
|--------------|-------------------|------------------------|-----------------|
| Misc. | Return loss (S11) | Return loss in Tx mode | For information |
| | | Return loss in Rx mode | For information |

Table 2. List of tests (US)

| US | | | | |
|---------------------|---------------------------|--------------|------------------------------|------|
| | <i>reference</i> | <i>limit</i> | <i>status</i> | |
| Transmission | Spurious 1 GHz – 12.5 GHz | FCC part15 | -41.12 dBm (1 MHz BW) | PASS |

3. Conducted tests

3.1. TX tests

3.1.1. Test setup

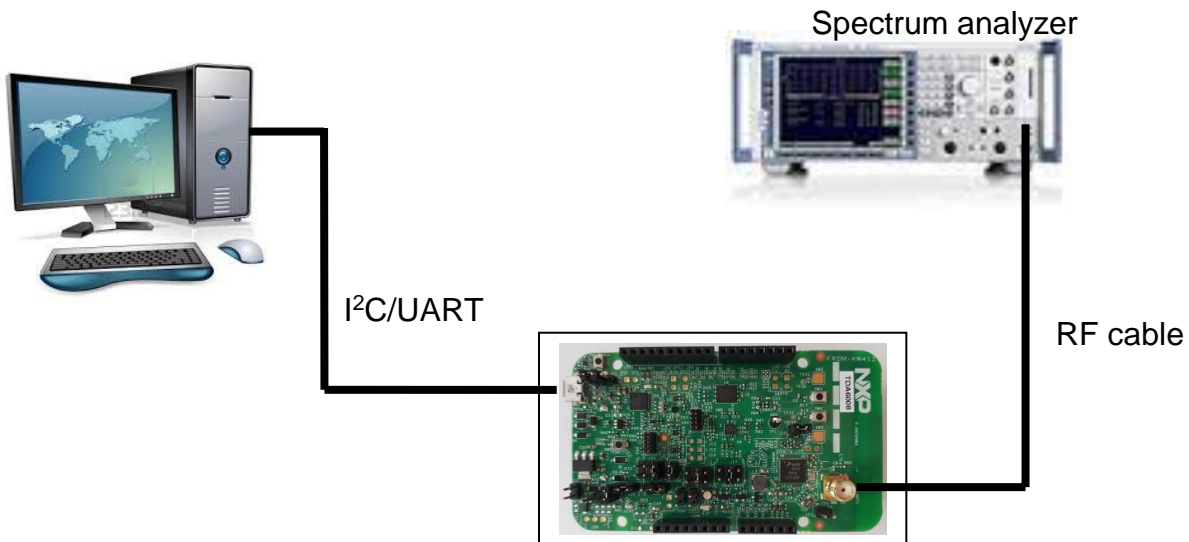

Figure 3. Conducted Tx test setup

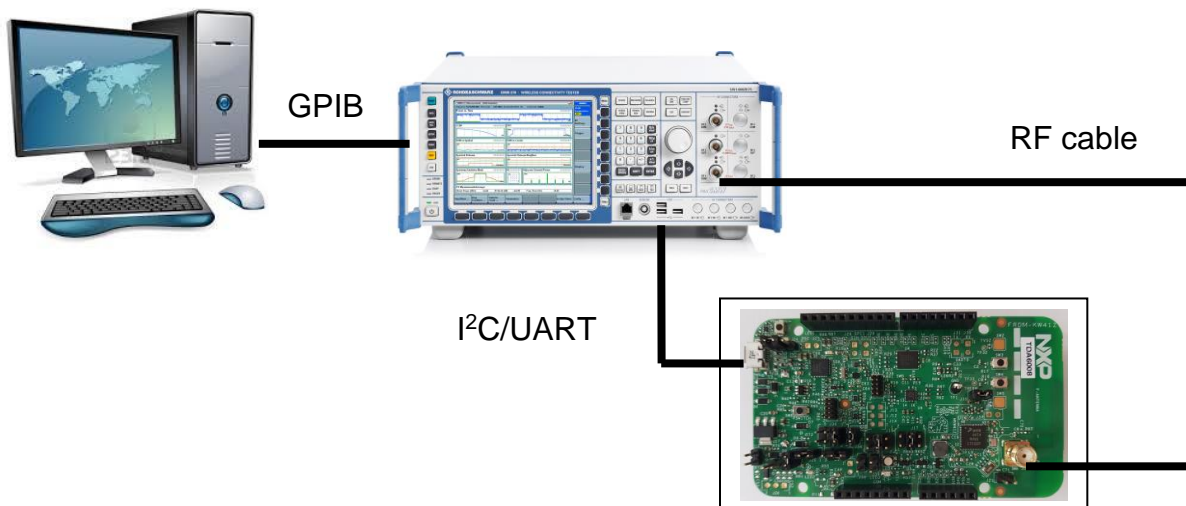

Figure 4. Specific conducted Tx test setup

3.1.2. Frequency accuracy

Test method:

- Set the radio to:
 - TX mode, CW, continuous mode, frequency: channel 19
- Set the analyzer to:
 - Center frequency = 2.44 GHz, span = 1 MHz, Ref amp = 20 dBm, RBW = 10 kHz, VBW = 100 kHz
- Measure the CW frequency with the marker of the spectrum analyzer

Result:

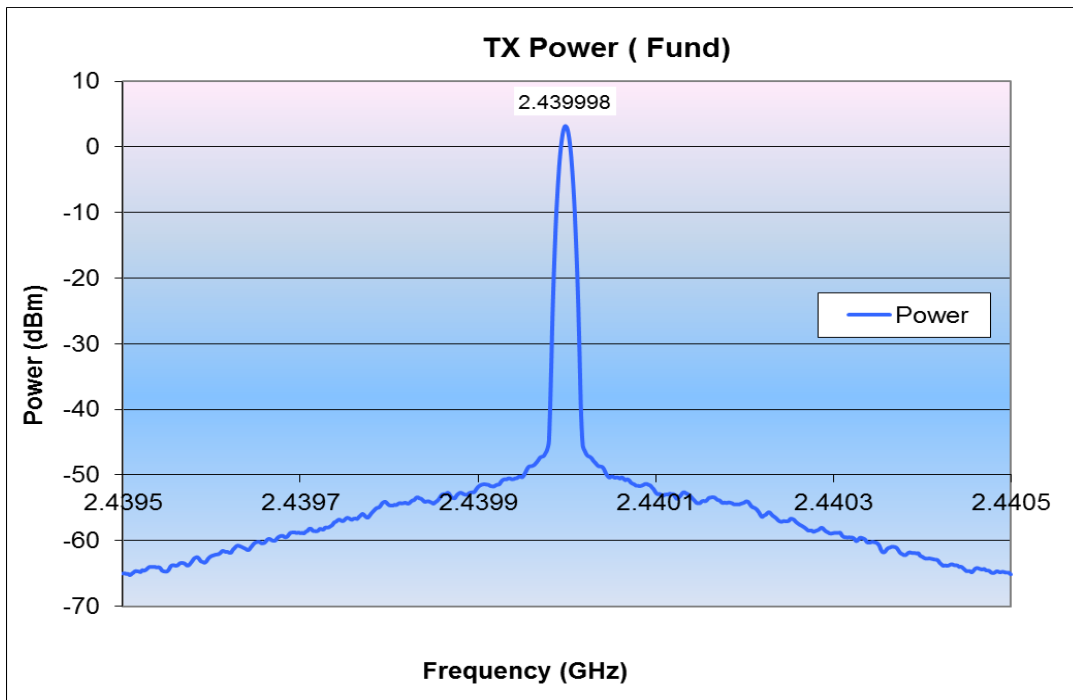

Figure 5. Frequency accuracy

- Measured frequency: 2.439998 GHz
- ppm value = $(2439998 - 2440000) / 2.440 = -0.8$ ppm

Table 3. Frequency accuracy

| Result | Target | 802.15.4 limit |
|----------|-----------|----------------|
| -1.6 ppm | +/-25 ppm | +/-40 ppm |

NOTE

The frequency accuracy depends on the XTAL model. The model used on the FRDM-KW41Z is Q22FA12800092 (Epson).

Conclusion:

- The frequency accuracy complies to the 802.15.4 specifications

3.1.3. Phase noise

Test method:

- Set the radio to:
 - TX mode, CW, continuous mode, frequency: channel 19
- Set the analyzer to:
 - Center frequency = 2.44 GHz, span = 1 MHz, Ref amp = 20 dBm, RBW = 10 kHz, VBW = 100 kHz
- Measure the phase noise at the 100-kHz offset frequency
 - RBW (spectrum analyzer) = 10 kHz ($20 \log(10 \text{ kHz}) = 40 \text{ dBc}$)

Result:

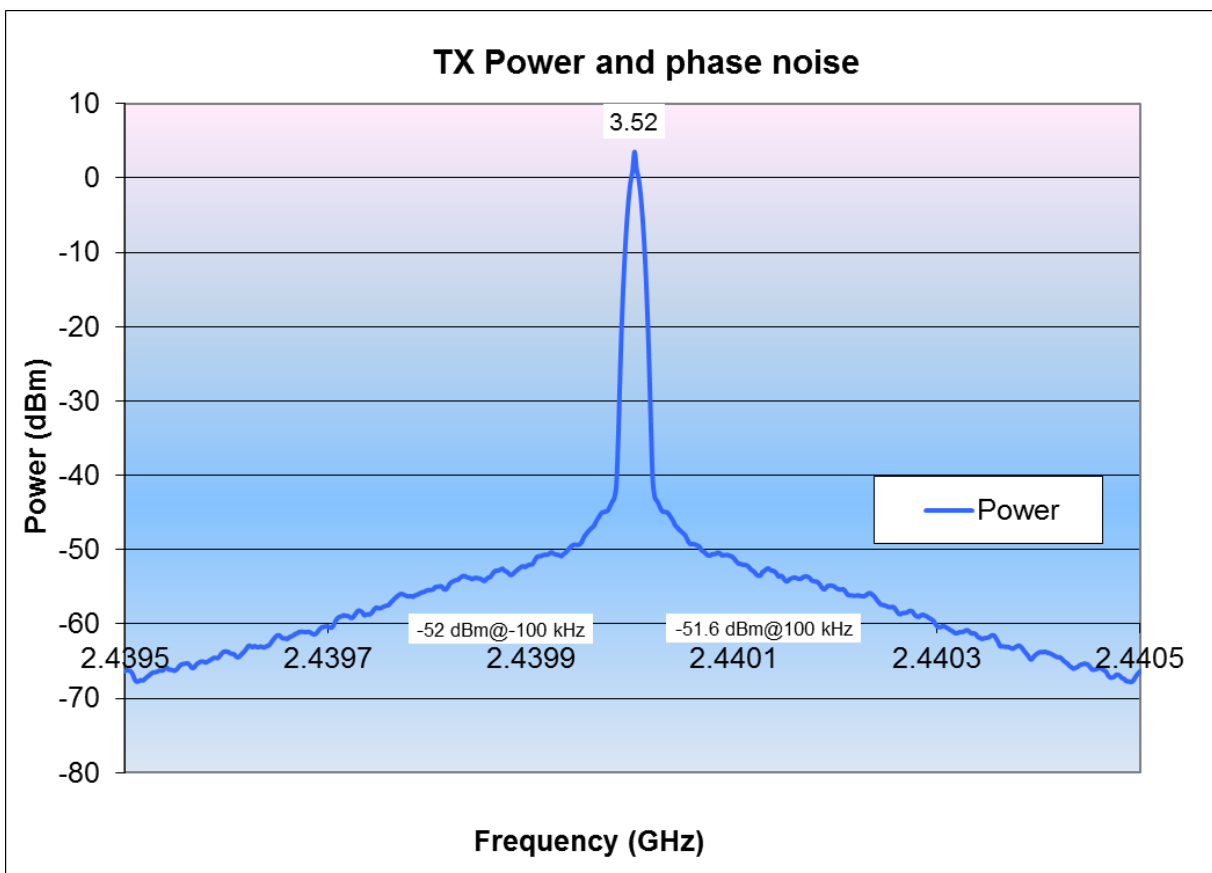

Figure 6. Conducted phase noise

- Marker value (delta) = $-51.6 \text{ dBm} / 100 \text{ kHz} = -95.1 \text{ dBc/Hz}$

NOTE

The phase noise is just for informational purposes. No specific issue on this parameter.

3.1.4. TX power (fundamental)

Test method:

- Set the radio to:
 - TX mode, modulated, continuous mode
- Set the analyzer to:
 - Start freq = 2.4 GHz, Stop freq = 2.5 GHz, Ref amp = 10 dBm, sweep time = 100 ms, RBW = 3 MHz, VBW = 3 MHz
 - Max Hold mode
 - Detector = RMS
- Sweep all the channels from channel 0 to channel 39

Result:

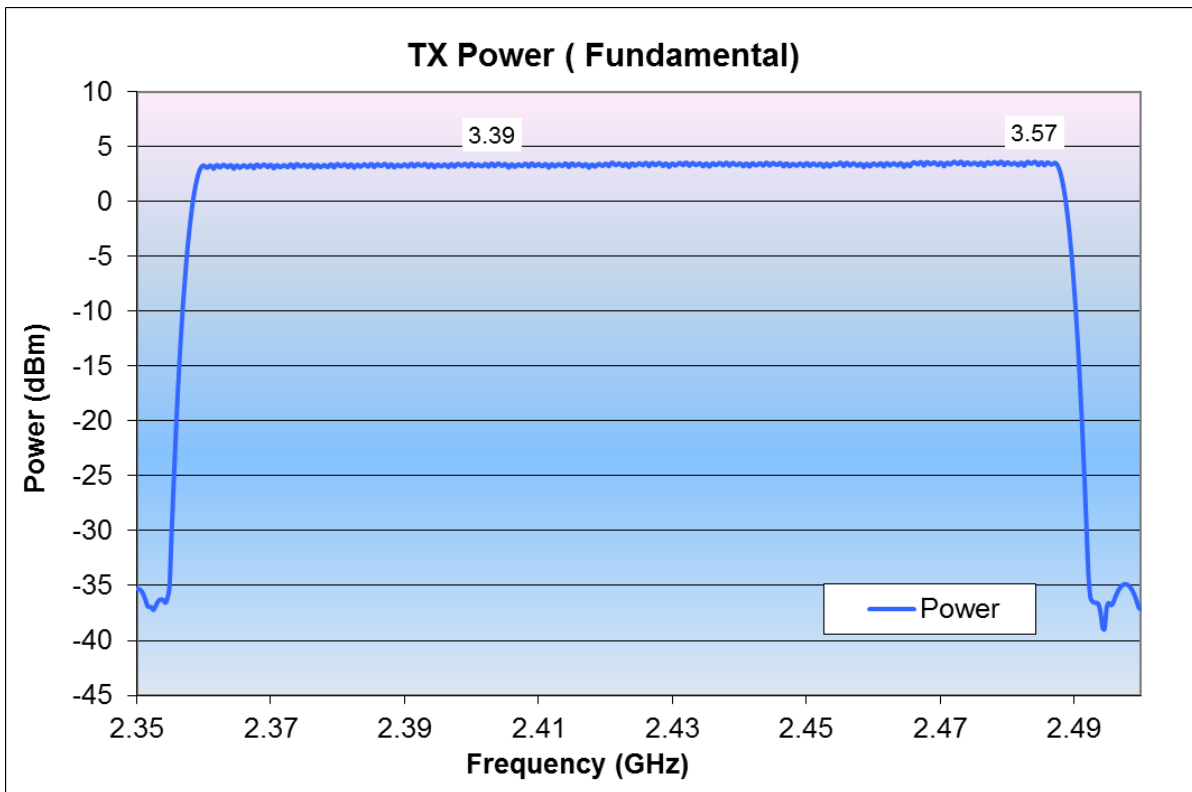

Figure 7. TX power

- Maximum power is on channel 39: 3.5 dBm
- Minimum power is on channel 0: 3.4 dBm
- Tilt over frequencies is 0.1 dB

Conclusion:

- These results are compliant with BLE 4.2

3.1.5. Tx power In Band

Test method:

- Set the radio to:
 - TX mode, modulated, continuous mode
- Set the analyzer to:
 - Start freq = 2.35 GHz, Stop freq = 2.5 GHz, Ref amp = 10 dBm, sweep time = 100 ms,
 - RBW = 100 kHz, Video BW = 300 kHz
 - Max Hold mode
 - Detector = RMS
 - Number of Sweeps = 10
- Sweep on channel 2, channel 19, and channel 37

Result:

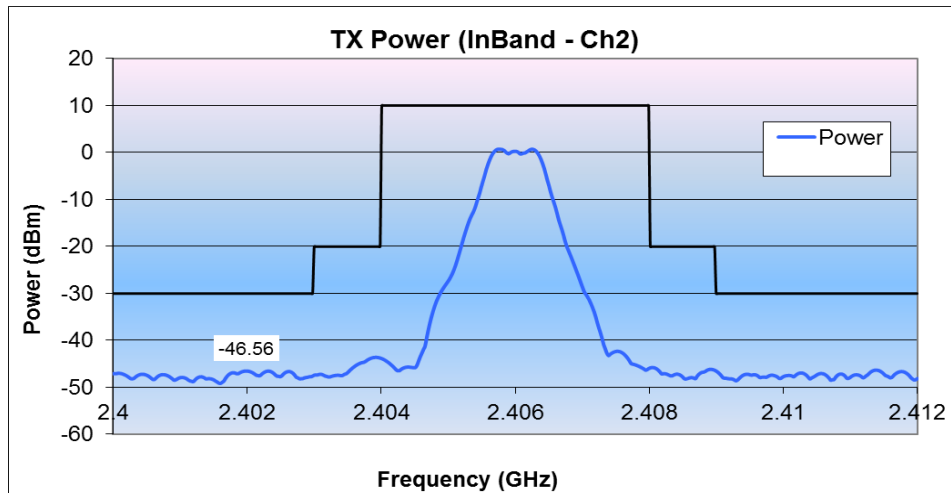

Figure 8. TX power In Band—channel 2

Table 4. TX power In Band—channel 2

| | | | | | |
|------------------------------|--------|-----|---|-------|-----|
| Max peak level ≤ -2 MHz | -43.66 | dBm | @ | 2.404 | GHz |
| Max peak level $\geq +2$ MHz | -45.82 | dBm | @ | 2.408 | GHz |
| Max peak level ≤ -3 MHz | -46.56 | dBm | @ | 2.402 | GHz |
| Max peak level $\geq +3$ MHz | -46.36 | dBm | @ | 2.411 | GHz |

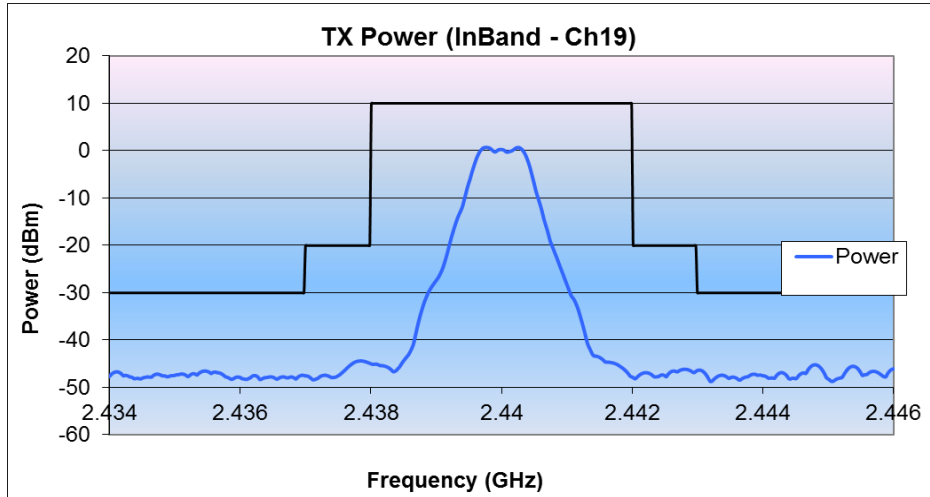

Figure 9. TX power In Band—channel 19

Table 5. TX power In Band—channel 19

| | | | | | |
|------------------------------|--------|-----|---|-------|-----|
| Max peak level ≤ -2 MHz | -44.35 | dBm | @ | 2.438 | GHz |
| Max peak level $\geq +2$ MHz | -46.11 | dBm | @ | 2.443 | GHz |
| Max peak level ≤ -3 MHz | -46.47 | dBm | @ | 2.435 | GHz |
| Max peak level $\geq +3$ MHz | -45.16 | dBm | @ | 2.445 | GHz |

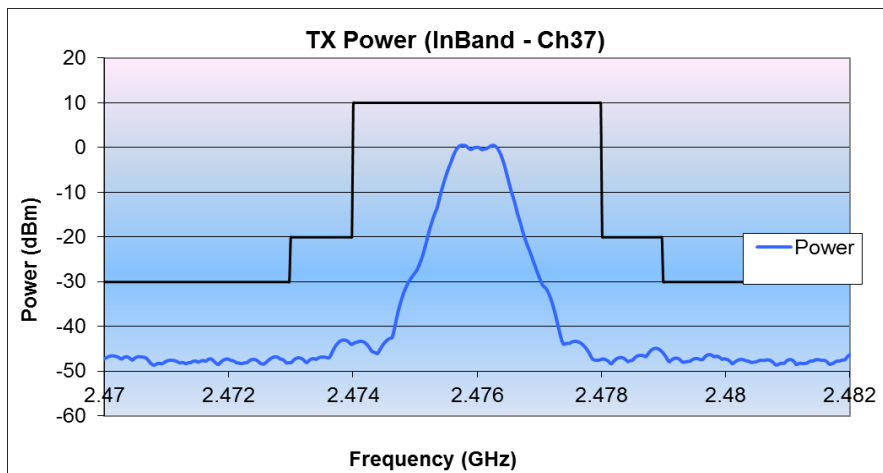

Figure 10. TX power In Band—channel 37

Table 6. TX power In Band—channel 37

| | | | | | |
|------------------------------|--------|-----|---|-------|-----|
| Max peak level ≤ -2 MHz | -42.97 | dBm | @ | 2.474 | GHz |
| Max peak level $\geq +2$ MHz | -44.84 | dBm | @ | 2.478 | GHz |
| Max peak level ≤ -3 MHz | -46.51 | dBm | @ | 2.470 | GHz |
| Max peak level $\geq +3$ MHz | -46.00 | dBm | @ | 2.479 | GHz |

Conclusion:

- These results are compliant with BLE 4.2

3.1.6. TX spurious

3.1.6.1. 30 MHz to 12.5 GHz

Spurious overview of the full band from 30 MHz to 12.5 GHz when the device is in the transmission mode.

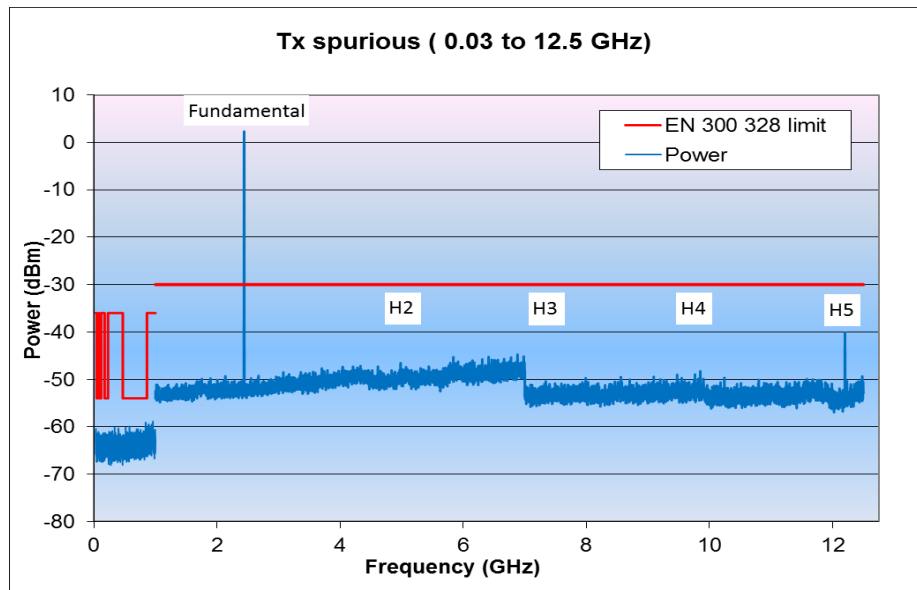

Figure 11. Conducted Tx spurious (30 MHz to 1 GHz)

Conclusion:

- There is more than 5-dB margin to the EN 300 328 limit

3.1.6.2. H2

Test method:

- Set the radio to:
 - Tx mode, modulated, continuous mode
- Set the analyzer to:
 - Start freq = 4.7 GHz, Stop freq = 5 GHz, Ref amp = -20 dBm, sweep time = 100 ms,
 - RBW = 1 MHz, VBW = 3 MHz
 - Max Hold mode
 - Detector: Peak
- Sweep all the channels from channel 0 to channel 39

Result:

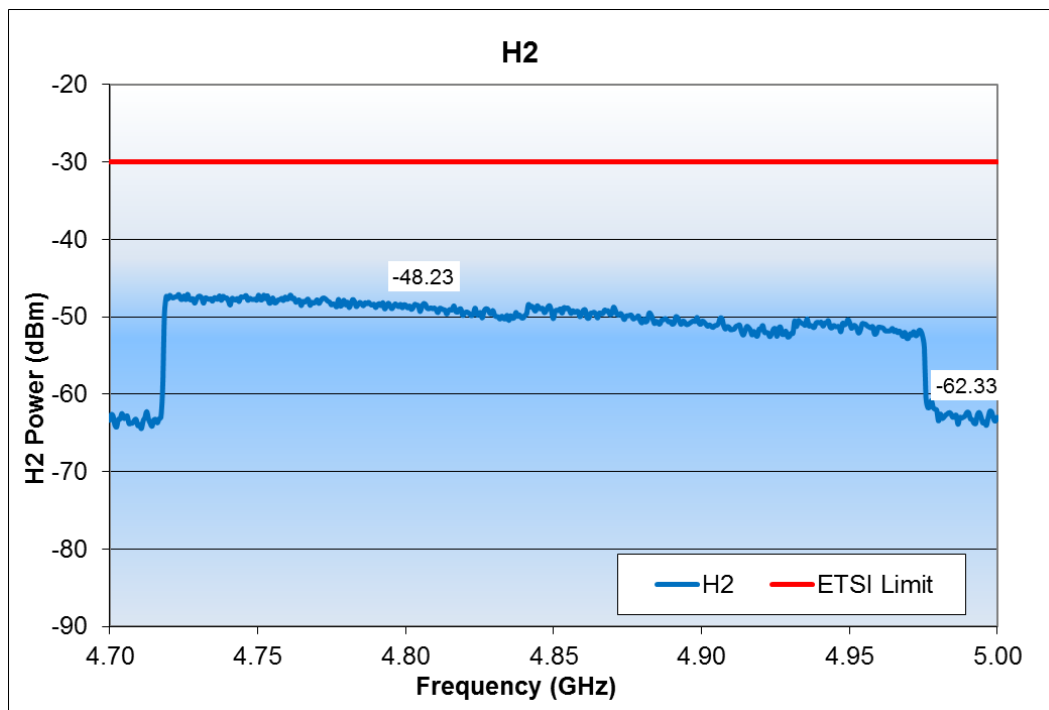

Figure 12. Conducted H2 spurious

- Maximum power is at channel 0: -48.2 dBm

Conclusion:

- Margin > 18 dB

3.1.6.3. H3

The same method as for H2, except that the spectrum analyzer frequency start/stop is set to 7.0 and 7.5 GHz.

Result:

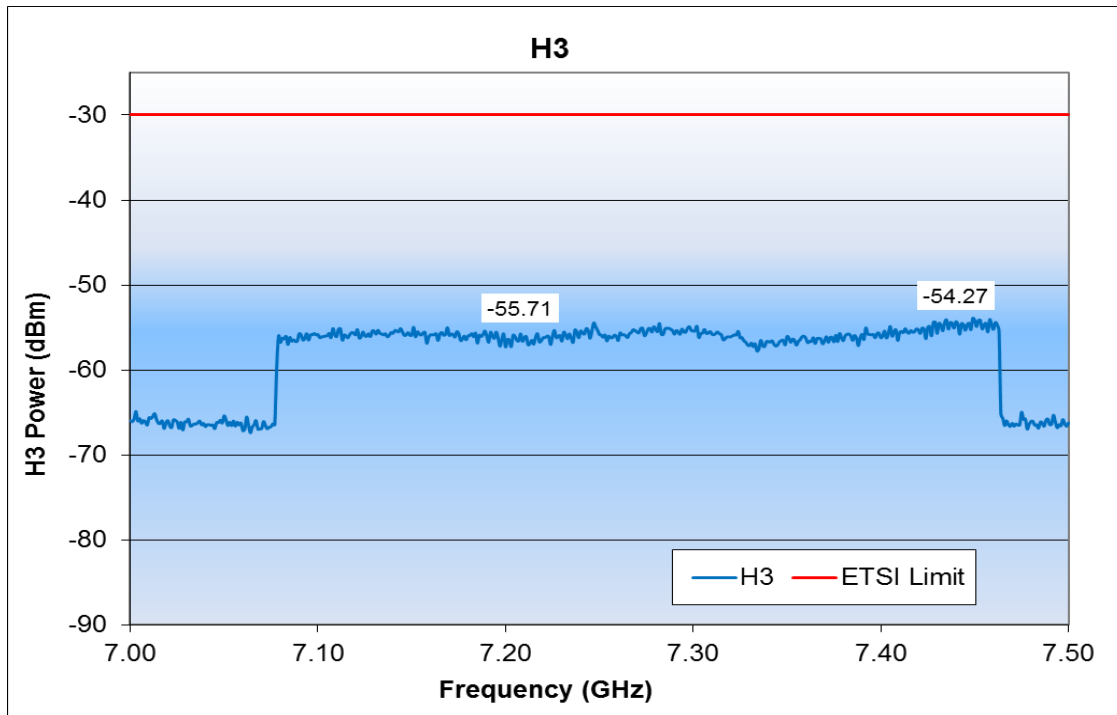

Figure 13. Conducted H3 spurious

- Maximum power is at channel 38: -54 dBm

Conclusion:

- Margin ≥ 24 dB

3.1.6.4. H4

Same method as for H2, except that the spectrum analyzer frequency span is set from 9.4 to 10.0 GHz.

Result:

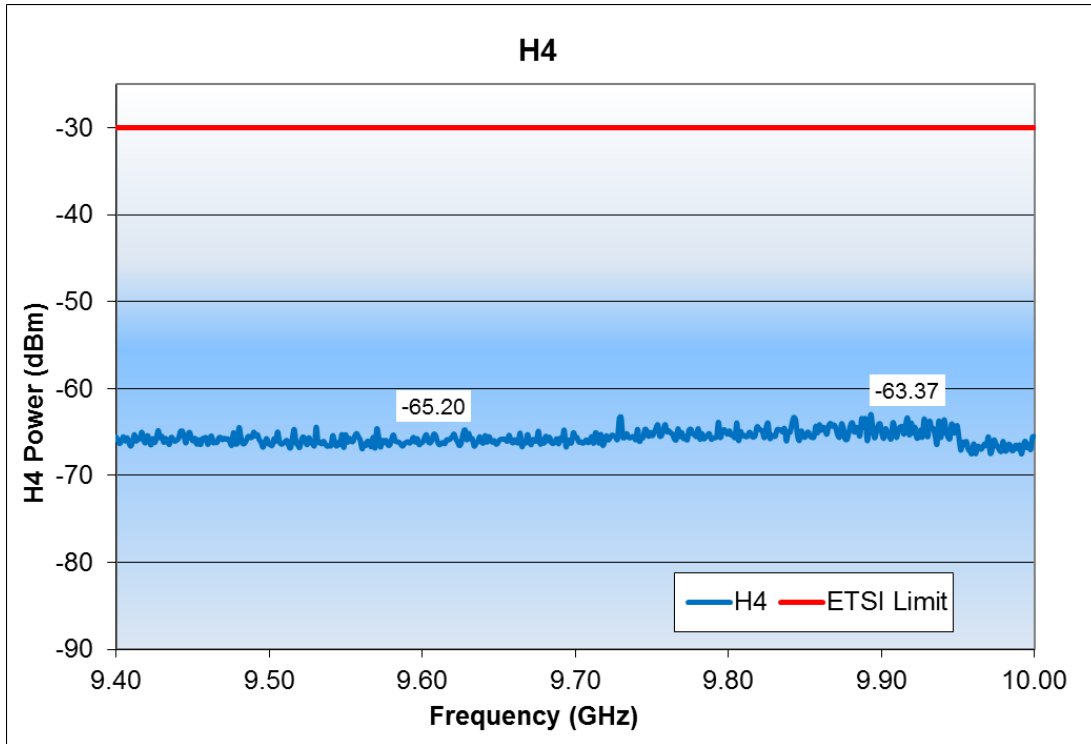

Figure 14. Conducted H4 spurious

- Maximum power is at channel 0: -63.4 dBm

Conclusion:

- Margin > 33 dB

3.1.6.5. H5

Same method as the H2, except that the spectrum analyzer frequency span is set from 11.7 GHz to 12.5 GHz.

Result:

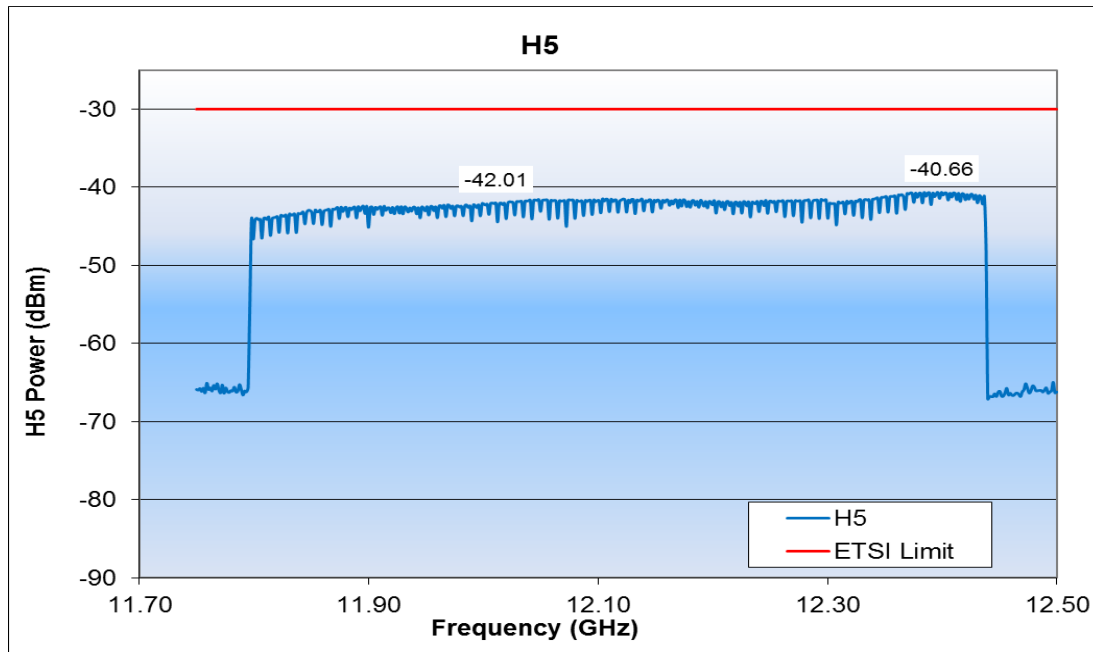

Figure 15. Conducted H5 spurious

- Maximum power is at channel 39: -40.7 dBm

Conclusion:

- Margin > 10 dB

3.1.6.6. H2 FCC

Test method:

- Set the radio to:
 - Tx mode, modulated, continuous mode
- Set the analyzer to:
 - Start freq = 4.7 GHz, Stop freq = 5 GHz, Ref amp = -20 dBm, sweep time = 100 ms, RBW = 1 MHz, VBW = 3 MHz
 - Trace: Max Hold mode
 - Detector: RMS
- Sweep all the channels from channel 0 to channel 39

Result:

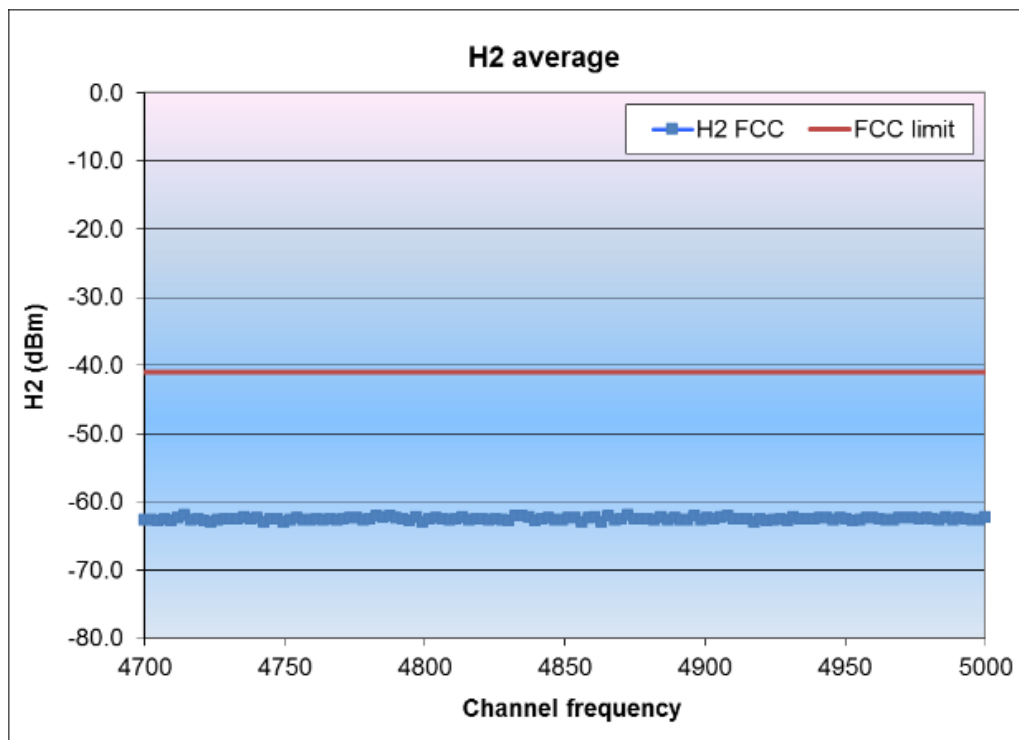

Figure 16. Conducted H2 FCC spurious

- Maximum power is at channel 22: -61.8 dBm

Conclusion:

- Margin > 33 dB

3.1.6.7. H3 FCC

Same method as the H2, except that the spectrum analyzer frequency span is set from 7.0 GHz to 7.5 GHz.

Result:

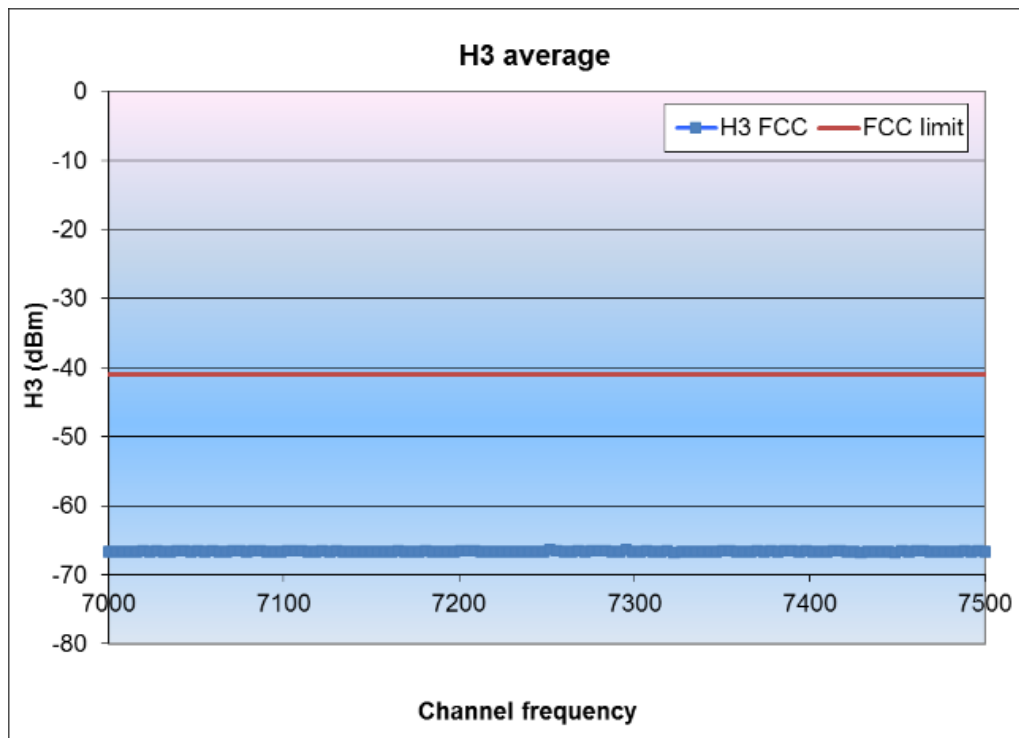

Figure 17. Conducted H3 FCC spurious

- Maximum power is at channel 8: -66.4 dBm

Conclusion:

- Margin > 25 dB

3.1.6.8. H4 FCC

Same method as the H2, except that the spectrum analyzer frequency span is set from 9.4 GHz to 10 GHz.

Result:

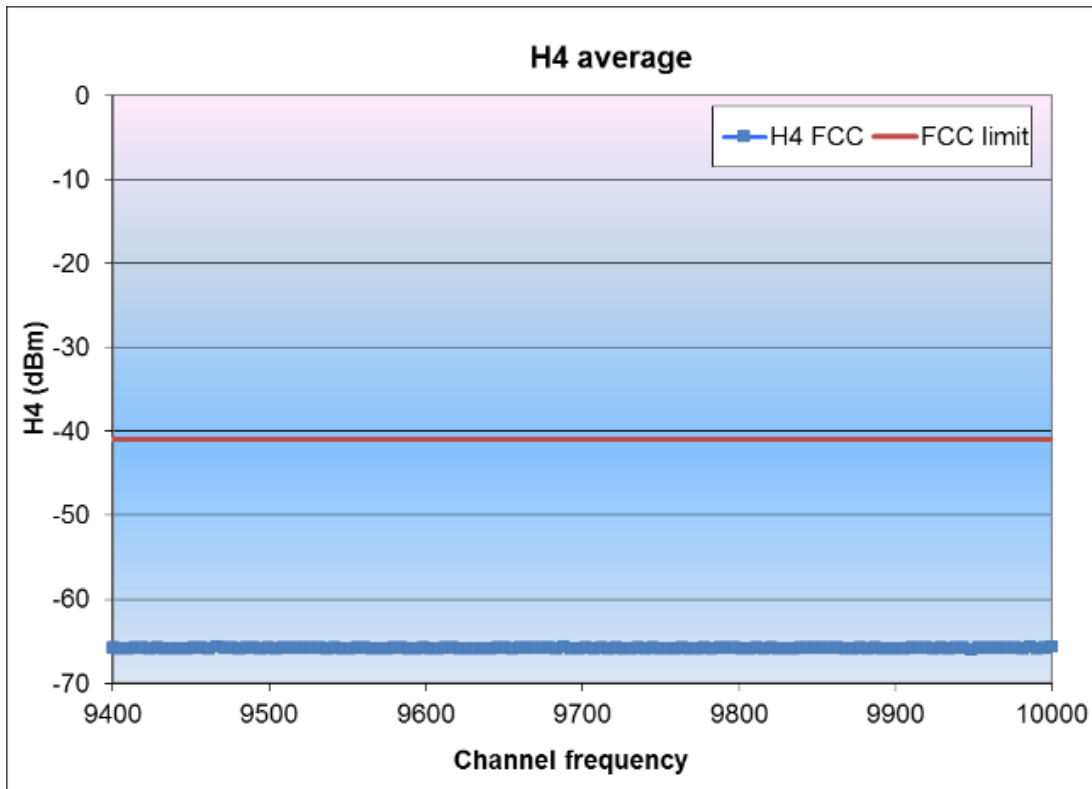

Figure 18. Conducted H4 FCC spurious

- Maximum power is at channel 39: -65.6 dBm

Conclusion:

- Margin > 24 dB

3.1.6.9. H5 FCC

Same method as the H2, except that the spectrum analyzer frequency span is set from 11.7 GHz to 12.5 GHz.

Result:

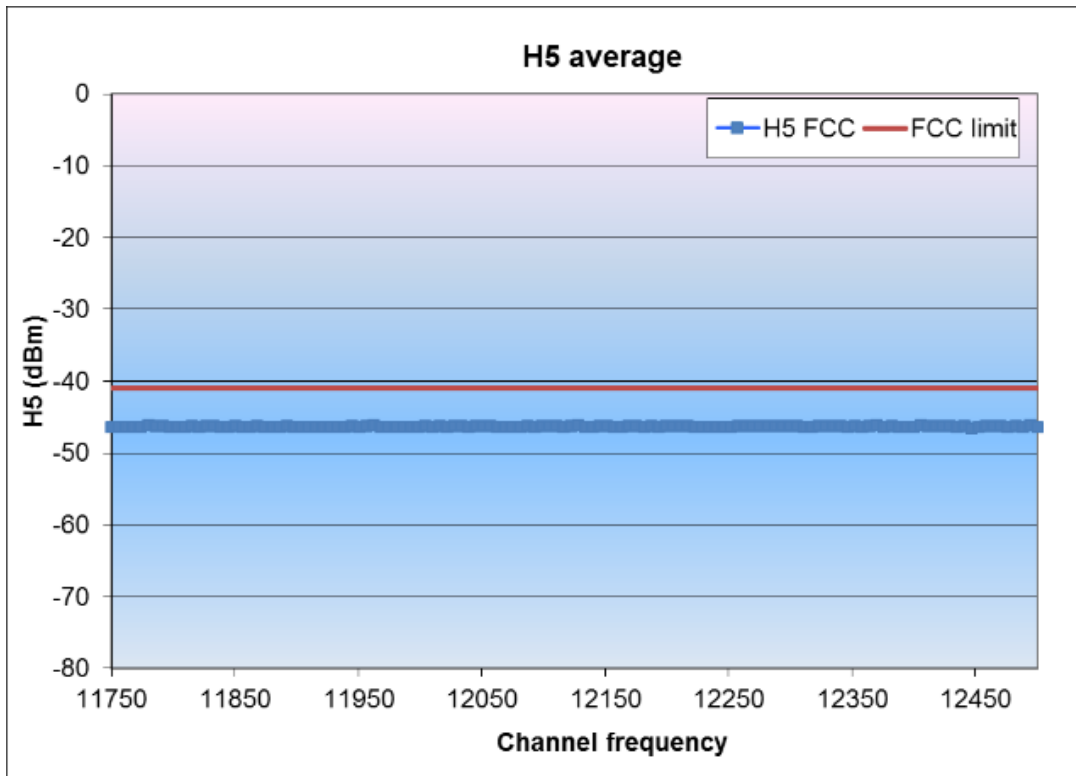

Figure 19. Conducted H5 FCC spurious

- Maximum power is at channel 39: -46.1 dBm

Conclusion:

- Margin > 5 dB

3.1.7. Modulation characteristics

A CMW equipment is used to measure the frequency deviations df1 and df2.

A specific binary file is flashed: *hci_blackbox.bin*.

Test method:

- Generator for the desired signal: CMW R&S
- Criterion: PER < 30.8 % with 1500 packets
- Channels under test: 0, 19, and 39

Result:

Table 7. Modulation characteristics

| TP/TRM-LE/CA/BV-05-C [Modulation Characteristics] | Lower Limit | Upper Limit | Measured | Unit | Status |
|---|-------------|-------------|----------|------|--------|
| Payload length: 37, Statistic Count: 10 | | | | | |
| Channel 0 | | | | | |
| Frequency Deviation df1 Average | 225 | 275 | 250.41 | kHz | Passed |
| Frequency Deviation df2 99.9% | 185 | --- | 221.33 | kHz | Passed |
| Frequency Deviation df2 Average / df1 Average | 0.80 | --- | 0.92 | --- | Passed |
| Channel 19 | | | | | |
| Frequency Deviation df1 Average | 225 | 275 | 250.45 | kHz | Passed |
| Frequency Deviation df2 99.9% | 185 | --- | 219.43 | kHz | Passed |
| Frequency Deviation df2 Average / df1 Average | 0.80 | --- | 0.92 | --- | Passed |
| Channel 39 | | | | | |
| Frequency Deviation df1 Average | 225 | 275 | 249.41 | kHz | Passed |
| Frequency Deviation df2 99.9% | 185 | --- | 221.13 | kHz | Passed |
| Frequency Deviation df2 Average / df1 Average | 0.80 | --- | 0.93 | --- | Passed |

Conclusion:

- Good margins, in line with the expected results

3.1.8. Carrier frequency offset and drift

A CMW equipment is used to measure the frequency deviations df1 and df2.

A specific binary file is flashed: *hci_blackbox.bin*

Test method:

- Generator for the desired signal: CMW270 R&S
- Criterion: PER < 30.8 % with 1500 packets
- Channels under test: 0, 19, and 39

Result:

Table 8. Carrier frequency offset and drift

| TP/TRM-LE/CA/BV-06-C [Carrier frequency offset and drift] | Lower Limit | Upper Limit | Measured | Unit | Status |
|---|-------------|-------------|----------|------|--------|
| Payload length: 37, Statistic Count: 10 | | | | | |
| Channel 0 | | | | | |
| Frequency Accuracy | -150.00 | 150.00 | 17.54 | kHz | Passed |
| Frequency Offset | -150.00 | 150.00 | 17.54 | kHz | Passed |
| Frequency Drift | -50.00 | 50.00 | 1.16 | kHz | Passed |
| Max Drift Rate | -20.00 | 20.00 | -1.60 | kHz | Passed |
| Initial Frequency Drift | -23.00 | 23.00 | -1.63 | kHz | Passed |
| Channel 19 | | | | | |
| Frequency Accuracy | -150.00 | 150.00 | 17.74 | kHz | Passed |
| Frequency Offset | -150.00 | 150.00 | 17.74 | kHz | Passed |
| Frequency Drift | -50.00 | 50.00 | 1.32 | kHz | Passed |
| Max Drift Rate | -20.00 | 20.00 | -2.05 | kHz | Passed |
| Initial Frequency Drift | -23.00 | 23.00 | -1.24 | kHz | Passed |
| Channel 39 | | | | | |
| Frequency Accuracy | -150.00 | 150.00 | 18.39 | kHz | Passed |
| Frequency Offset | -150.00 | 150.00 | 18.39 | kHz | Passed |
| Frequency Drift | -50.00 | 50.00 | 1.58 | kHz | Passed |
| Max Drift Rate | -20.00 | 20.00 | -1.78 | kHz | Passed |
| Initial Frequency Drift | -23.00 | 23.00 | -1.52 | kHz | Passed |

Conclusion:

- Good margins, in line with the expected results

3.2. RX tests

3.2.1. Test setup

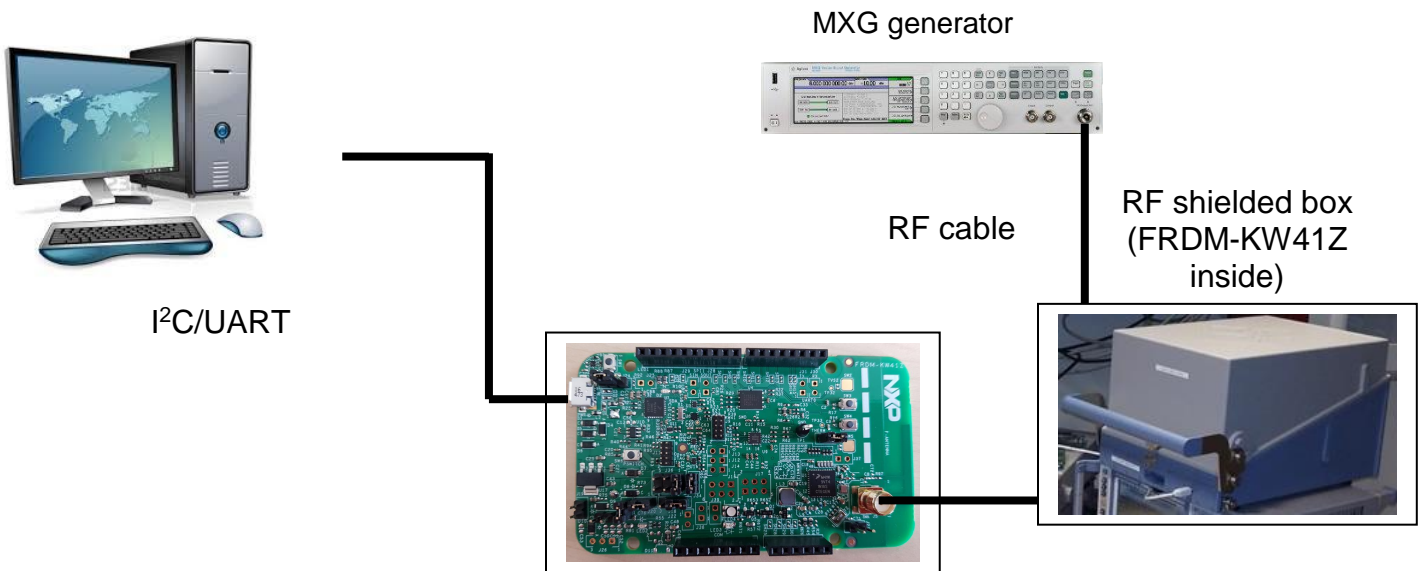

Figure 20. Conducted Rx test setup for sensitivity with RF generator and faraday box

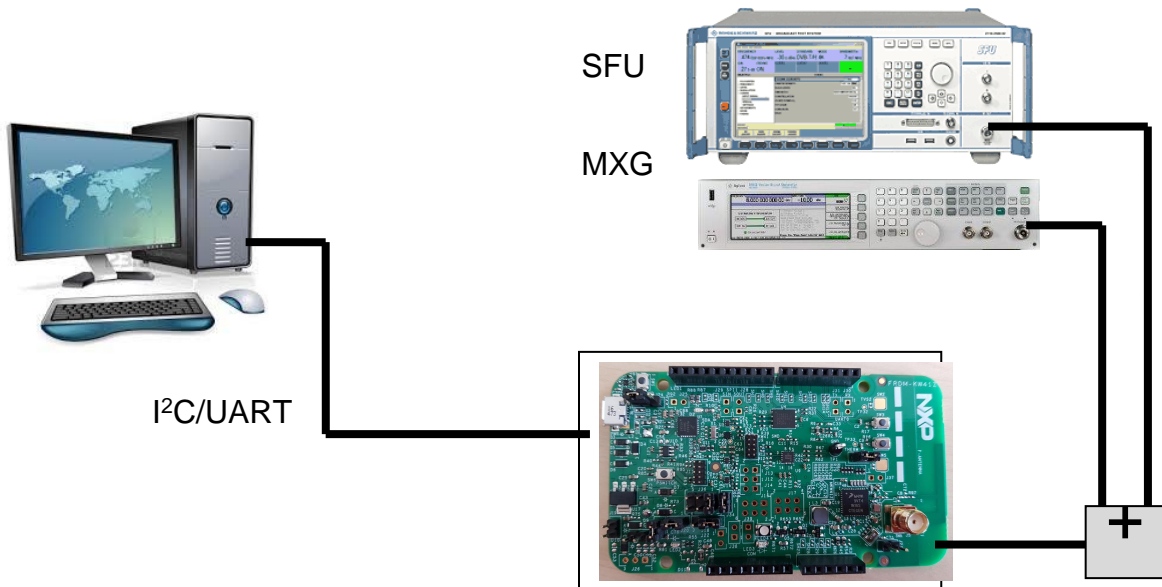

Figure 21. Conducted Rx test setup for interference rejection

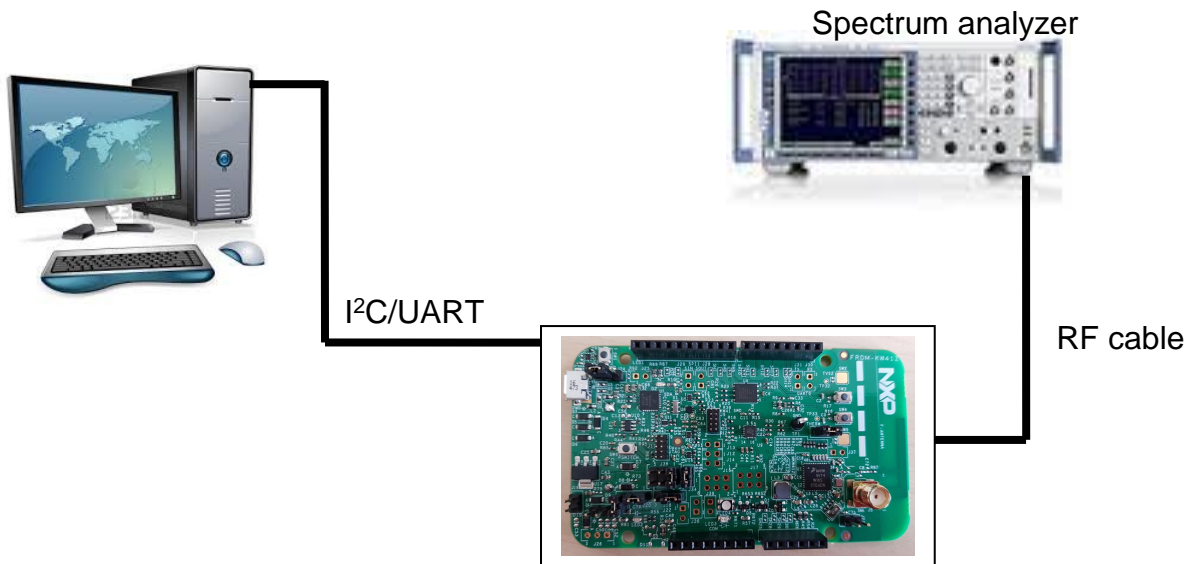

Figure 22. Conducted Rx test setup for spurious

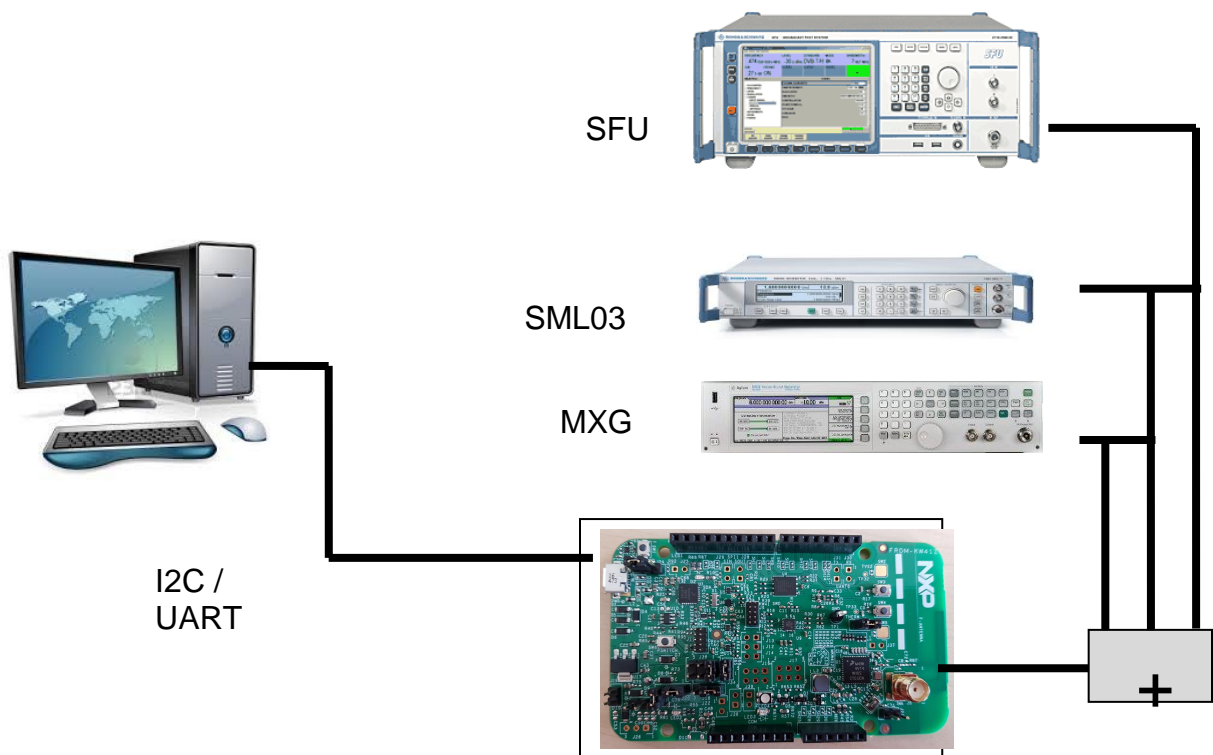

Figure 23. Conducted Rx test setup for intermodulation performances

3.2.2. Sensitivity

3.2.2.1. With the ARB generator

Test method:

- To be immune to the external parasitic signals, the FRDM-KW41Z is put into an RF shielded box



Figure 24. Sensitivity test

The generator (Agilent NX5181 MXG) is used in the ARB mode to generate a pattern of 1500 packets. The TERATERM window is used to control the module.

- Set it to channel 0
- The connection is automatically established and the PER (Packet Error Rate) is measured
- Decrease the level of the SFU at the RF input of the module until PER = 30.8 %
- Repeat it up to channel 39

Results:

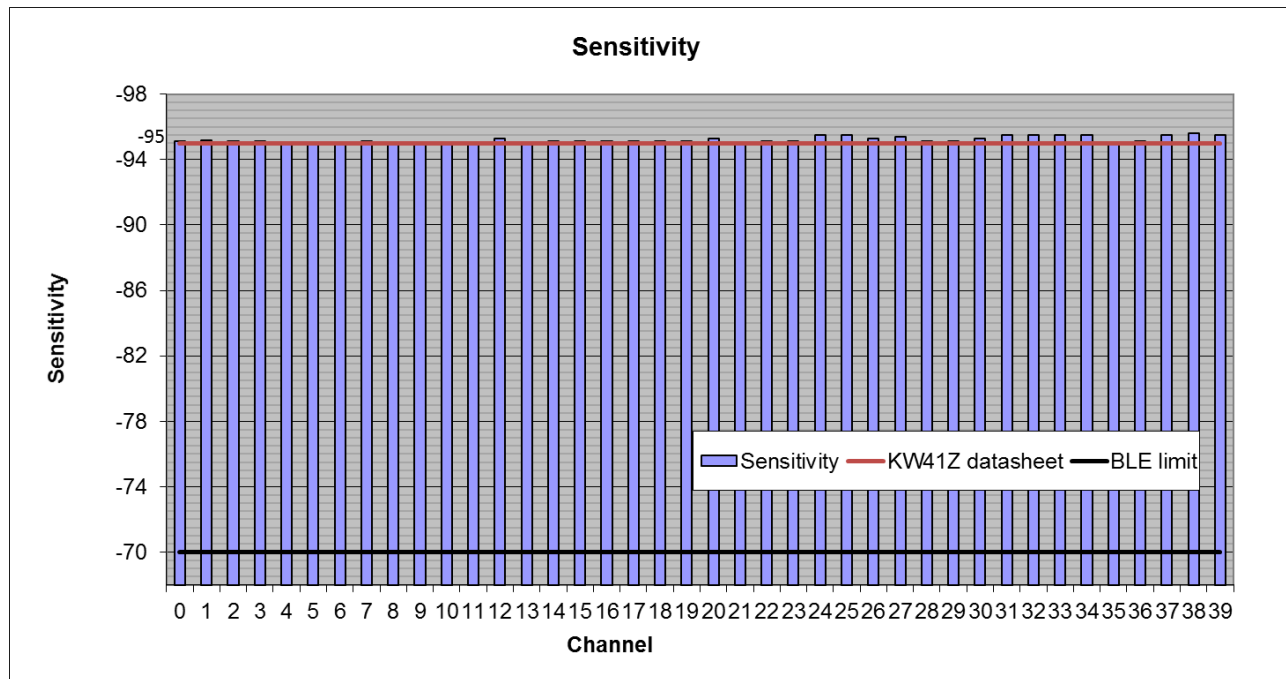

Figure 25. Sensitivity result

- The highest sensitivity is on channel 0: -95.6 dBm
- The lowest sensitivity is on channel 39: -94.9 dBm
- Delta over channels: 0.7 dB

Conclusion:

- The FRDM-KW41Z shows an average value of -95 dBm

3.2.3. Receiver maximum input level

Test method:

- The same test setup as with the sensitivity test is used
- The signal level is increased up to PER = 30.8 % with 1500 packets

Results:

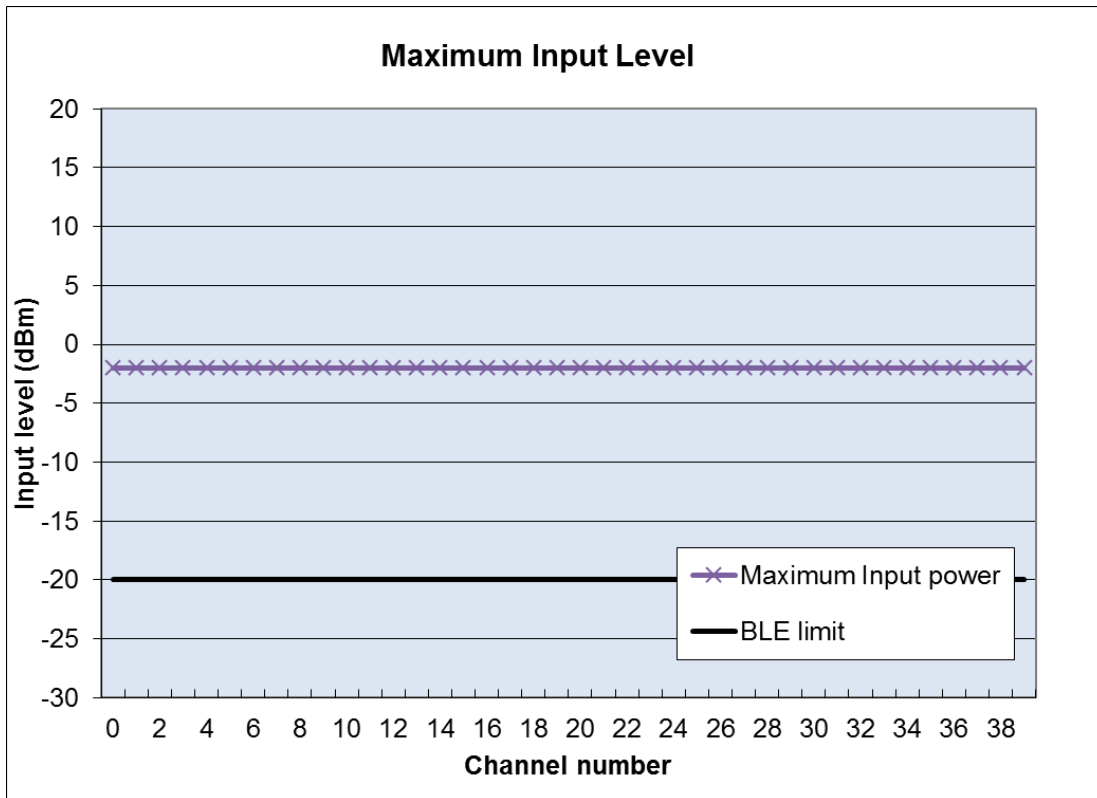

Figure 26. Maximum input level

Conclusion:

- The results are in line with the expected values

3.2.4. RX spurious

Test method:

- Set the radio to:
 - Receiver mode, frequency: channel 18
- Set the analyzer to:
 - Ref amp = -20 dBm, Trace = max hold, detector = max peak
 - Start/stop frequency: 30 MHz/1 GHz
 - RBW = 100 kHz, VBW = 300 kHz
 - Then set the start/stop frequency: 1 GHz/30 GHz
 - RBW = 1 MHz, VBW = 3 MHz

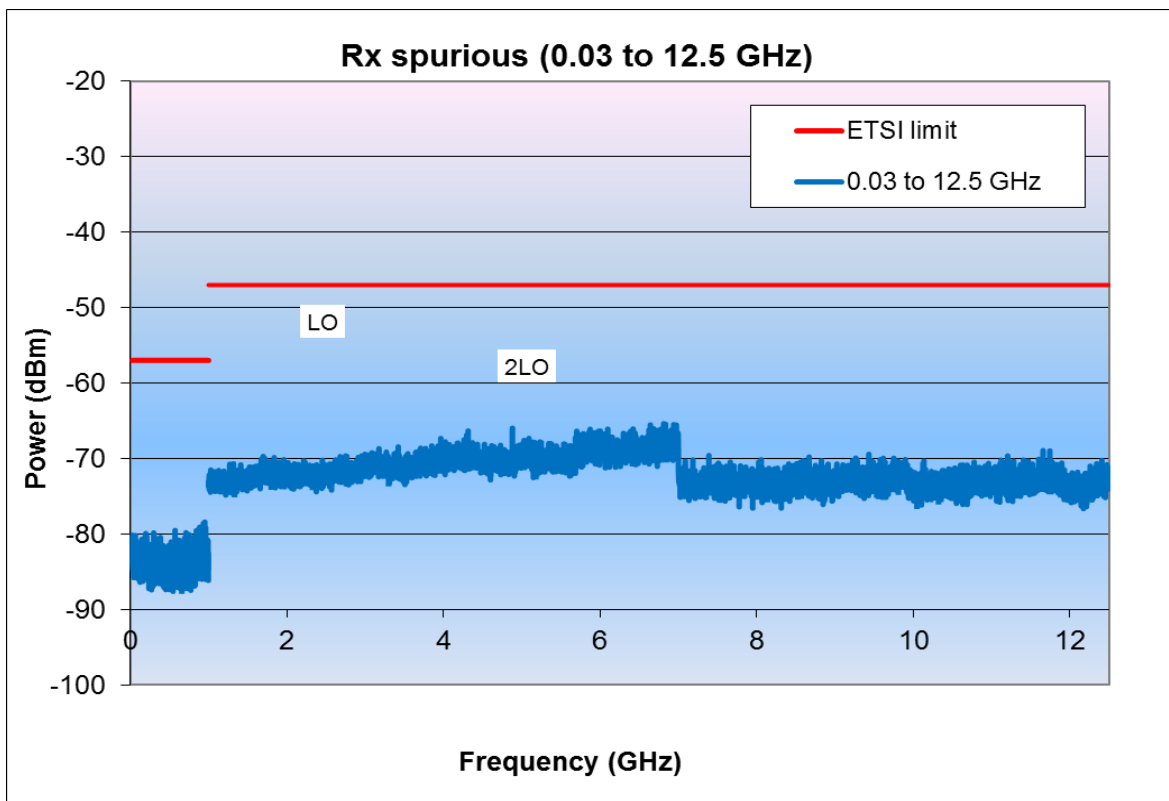

Figure 27. Conducted Rx spurious 30 MHz – 12.5 GHz

Conclusion:

- There are no spurs above the spectrum analyzer noise floor, except for 2xLO
- More than 15-dB margin

3.2.5. Receiver interference rejection performances

3.2.5.1. Adjacent, alternate, and co-channel rejection

The interferers are located at the adjacent channels (+/-1 MHz, +/-2 MHz, +/-3 MHz) or a co-channel. The test is performed with only one interfering signal at a time.

Test method:

- Generator for the desired signal: Agilent N5182A
- Generator for the interferers: R&S SFU
- Criterion: PER < 30.8 % with 1500 packets
- The wanted signal is set to -67 dBm; the interferer is increased until the PER threshold is reached
- Channels under test: 2, 19, and 37

Results:

Table 9. Adjacent, alternate, and co-channel rejection

| ch2 2406 | | | | | ch19 2440 | | | | ch37 2476 | | | |
|---------------------------|--------|--------|--------|--------|--------------|--------|--------|--------|--------------|--------|--------|--------|
| | N-2MHz | N-1MHz | N+1MHz | N+2MHz | N-2MHz | N-1MHz | N+1MHz | N+2MHz | N-2MHz | N-1MHz | N+1MHz | N+2MHz |
| Interferer level (C/I dB) | -44.9 | -4.4 | -3.9 | -44.4 | -44.9 | -3.9 | -3.4 | -44.4 | -44.9 | -3.9 | -3.9 | -44.4 |
| BLE 4.2 limit (C/I dB) | -17 | 15 | 15 | -17 | -17 | 15 | 15 | -17 | -17 | 15 | 15 | -17 |
| Margin (dB) | 27.9 | 19.4 | 18.9 | 27.4 | 27.9 | 18.9 | 18.4 | 27.4 | 27.9 | 18.9 | 18.9 | 27.4 |

| ch2 2406 | | Co-channel ch2 2406 | | ch19 2440 | | Co-channel ch19 2440 | | ch37 2476 | | Co-channel ch37 2476 | |
|---------------------------|--------|---------------------------|------|--------------|--------|----------------------------|--------|--------------|------|----------------------------|--------|
| | N-3MHz | N+3MHz | N | N-3MHz | N+3MHz | N | N-3MHz | N+3MHz | N | N-3MHz | N+3MHz |
| Interferer level (C/I dB) | -49.4 | -48.4 | 2406 | -49.4 | -48.4 | 2440 | -49.4 | -48.4 | 2476 | -49.4 | -48.4 |
| BLE 4.2 limit (C/I dB) | -27 | -26 | 2406 | -27 | -26 | 2440 | -27 | -26 | 2476 | -27 | -26 |
| Margin (dB) | 22.4 | 22.4 | 5.1 | 22.4 | 22.4 | 5.6 | 22.4 | 22.4 | 5.1 | 22.4 | 22.4 |
| | | | 21 | | | 21 | | | 21 | | |
| | | | 15.9 | | | 15.4 | | | 15.9 | | |

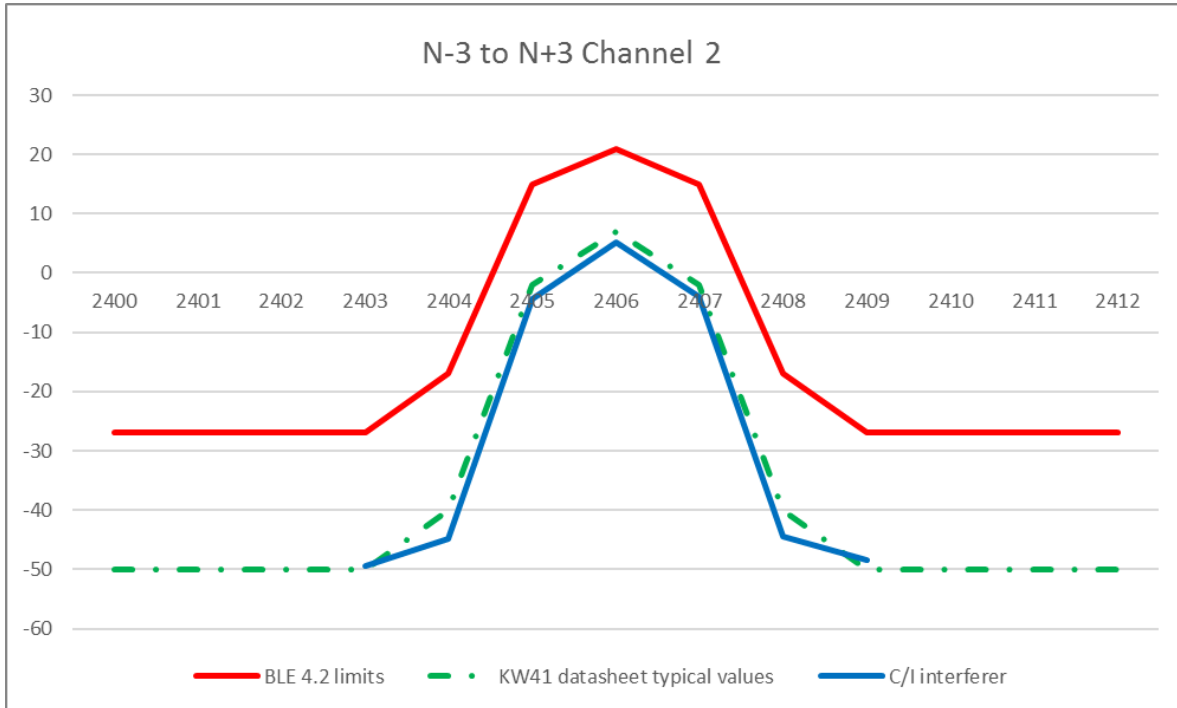

Figure 28. Adjacent, alternate, and co-channel rejection @channel2

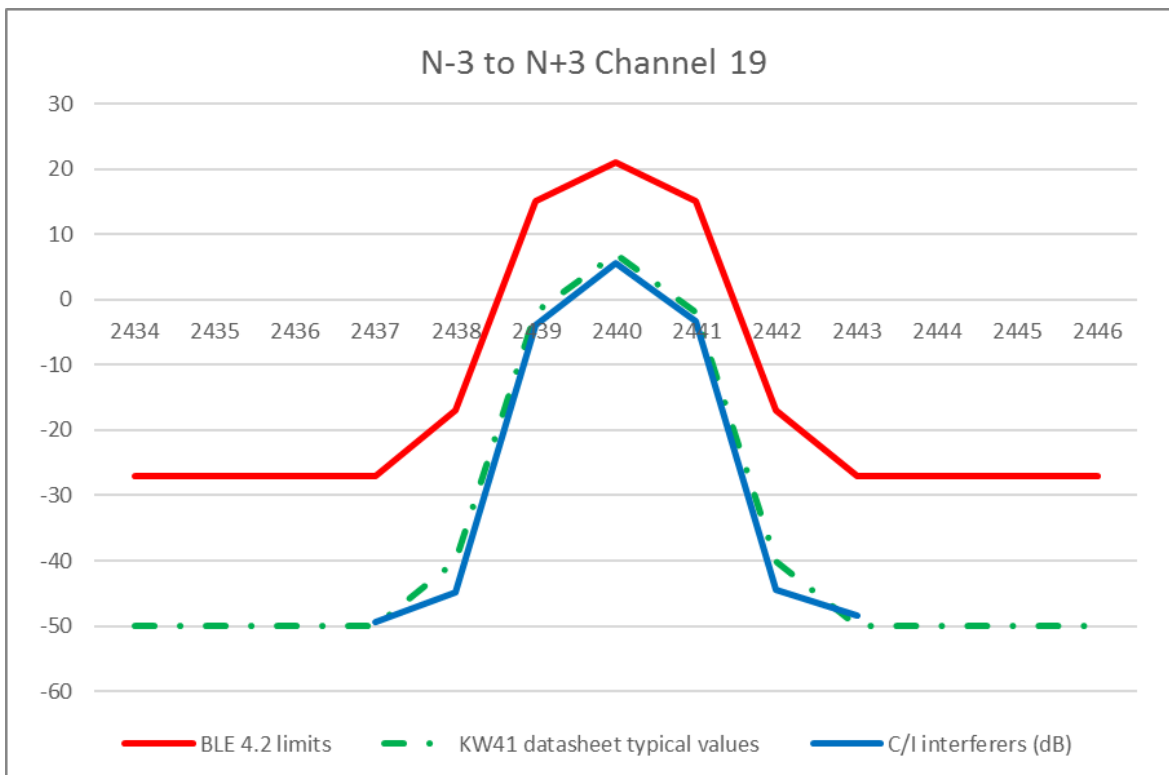

Figure 29. Adjacent, alternate, and co-channel rejection @channel19

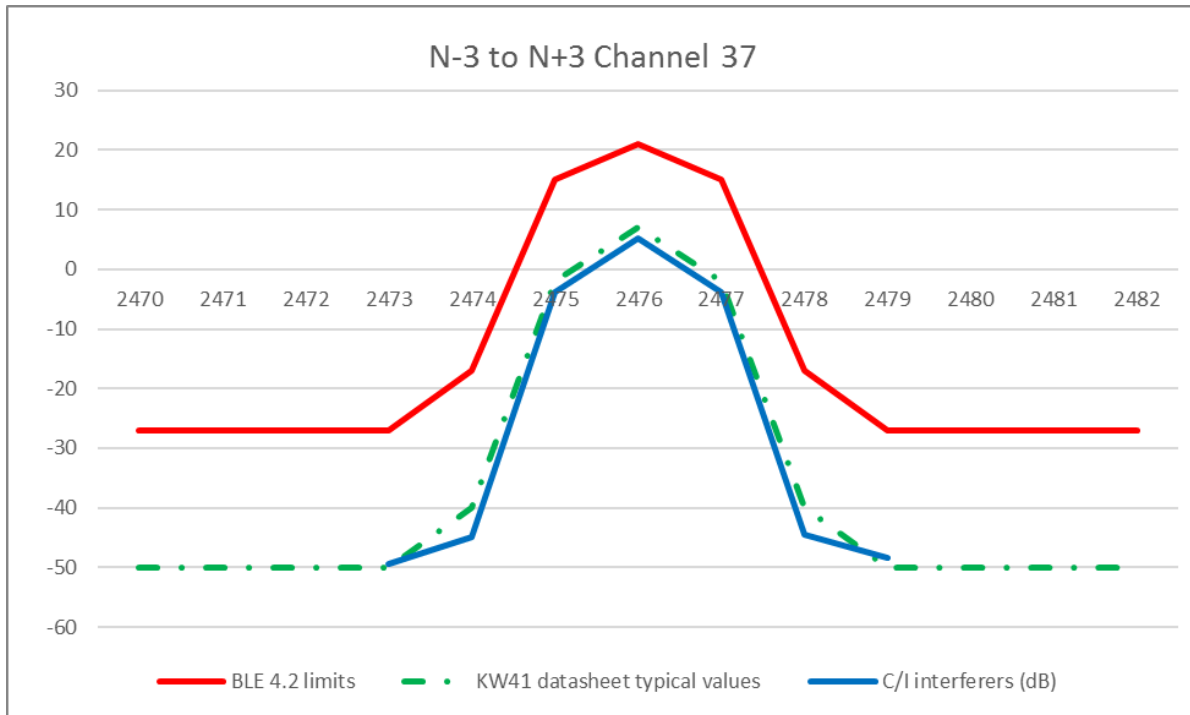

Figure 30. Adjacent, alternate, and co-channel rejection @channel37

Conclusion:

- Good margin, in line with the expected results

3.2.5.2. Receiver blocking

The blocking interferers are located at the out-of-band channels, depending on the receiver category.

Receiver category 1. (See the 300.328 2.1.1 chapter 4.3.1.12.4.2)

The test is performed with only one interfering signal at a time.

Test method:

- Generator for the desired signal: Agilent N5182A
- Generator for the interferers: R&S SFU
- Criterion: PER < 10 %
- The wanted signal is set to Pmin + 6 dB (-88 dBm); the interferer is increased until the PER threshold is reached
- Channels under the test: 0 and 39

Result:

Table 10. Receiver blocking (out-of-band) rejection

| | ch0 | ch0 | ch39 | ch39 |
|------------------------|--------------|--------------|--------------|--------------|
| | 2402 | 2402 | 2480 | 2480 |
| | Low | High | Low | High |
| | 2380 | 2503.5 | 2380 | 2503.5 |
| Interferer level (dBm) | -19.1 | -16.6 | -17.6 | -16.1 |
| 802.15.4 limit (dBm) | -53 | -53 | -53 | -53 |
| Margin (dB) | 33.9 | 36.4 | 35.4 | 36.9 |

| | ch0 | ch0 | ch0 | ch39 | ch39 | ch39 |
|------------------------|--------------|--------------|--------------|--------------|--------------|--------------|
| | 2402 | 2402 | 2402 | 2480 | 2480 | 2480 |
| | Low | Low | Low | Low | Low | Low |
| | 2300 | 2330 | 2360 | 2300 | 2330 | 2360 |
| Interferer level (dBm) | -17.6 | -17.6 | -17.6 | -16.1 | -16.6 | -17.6 |
| 802.15.4 limit (dBm) | -47 | -47 | -47 | -47 | -47 | -47 |
| Margin (dB) | 29.4 | 29.4 | 29.4 | 30.9 | 30.4 | 29.4 |

| | ch0 | ch0 | ch0 | ch0 | ch0 | ch0 |
|------------------------|--------------|--------------|--------------|--------------|--------------|--------------|
| | 2402 | 2402 | 2402 | 2402 | 2402 | 2402 |
| | High | High | High | High | High | High |
| | 2523.5 | 2553.5 | 2583.5 | 2613.5 | 2643.5 | 2673.5 |
| Interferer level (dBm) | -16.1 | -15.6 | -14.6 | -13.6 | -12.6 | -12.1 |
| 802.15.4 limit (dBm) | -47 | -47 | -47 | -47 | -47 | -47 |
| Margin (dB) | 30.9 | 31.4 | 32.4 | 33.4 | 34.4 | 34.9 |

Conclusion:

- Good margin, in line with the expected results

Receiver category 2 (See the 300.328 2.1.1 chapter 4.3.1.12.4.3)

The test is performed with only one interfering signal at a time.

Test method:

- Generator for the desired signal: Agilent N5182A
- Generator for the interferers: R&S SFU
- Criterion: PER < 10 %
- The wanted signal is set to Pmin + 6 dB (-88 dBm); the interferer is increased until the PER threshold is reached
- Channels under the test: 0 and 39

Result:

Table 11. Receiver blocking (out-of-band) rejection

| | ch0 | ch0 | ch39 | ch39 |
|------------------------|-------|--------|-------|--------|
| | 2402 | 2402 | 2480 | 2480 |
| | Low | Low | High | High |
| | 2380 | 2503.5 | 2380 | 2503.5 |
| Interferer level (dBm) | -19.6 | -17.1 | -18.1 | -16.6 |
| 802.15.4 limit (dBm) | -57 | -57 | -57 | -57 |
| Margin (dB) | 37.4 | 39.9 | 38.9 | 40.4 |

| | ch0 | ch0 | ch39 | ch39 |
|------------------------|-------|--------|-------|--------|
| | 2402 | 2402 | 2480 | 2480 |
| | Low | Low | High | High |
| | 2300 | 2583.5 | 2300 | 2583.5 |
| Interferer level (dBm) | -18.1 | -15.1 | -16.6 | -16.6 |
| 802.15.4 limit (dBm) | -47 | -47 | -47 | -47 |
| Margin (dB) | 28.9 | 31.9 | 30.4 | 30.4 |

Conclusion:

- Good margin, in line with the expected results

3.2.5.3. Blocking interferers

A CW is used as the interferer source to verify that the receiver performs satisfactorily with a frequency outside the 2400 MHz – 2483.5 MHz band.

Test method:

- Generator for the desired signal: Agilent N5182A
- Generator for the blocker: R&S SFU
- Criterion: PER < 30.8 % with 1500 packets
- The wanted signal is set to -67 dBm; the interferer level is increased until the PER threshold is reached
- Channel under the test: 12 (2426 MHz)

Table 12. Blocking interferers

| Wanted signal 2426 MHz @ -67 dBm | ch12 2426 MHz | ch12 2426 MHz | ch12 2426 MHz | ch12 2426 MHz | |
|-------------------------------------|----------------------------|-----------------------------|-----------------------------|----------------------------------|-------------------------------------|
| Interferer (MHz) | 30 – 2000 (step 10 MHz) | 2003 – 2399 (step 3 MHz) | 2484 – 2997 (step 3 MHz) | 3 GHz-12.75 GHz (step 25 MHz) | |
| Unwanted level (dBm) | -30 | -35 | -35 | -30 | |
| Status (unwanted level) | PASS | PASS | PASS | PASS | |
| Number of blocking fail | 0 | 0 | 0 | 0 | Fail blockers must not exceed 10 |
| Status (UnW level -50 dBm) | PASS | PASS | PASS | PASS | |
| Number of blocking fail | 0 | 0 | 0 | 0 | Fail blockers must not exceed 3 |

Conclusion: Good margin, in line with the expected results

3.2.6. Intermodulation

This test verifies that the receiver intermodulation performance is satisfactory.

Two interferers are used in combination with the wanted signal. One interferer is a sinusoid non-modulated signal and the second interferer is a modulated signal with the PRSB15 data.

Test method:

- Generator for the desired signal: Agilent N5182A
- Generator for the first interferer (CW): R&S SML03
- Generator for the second interferer (PRBS15): R&S SFU
- Criterion: PER < 30.8 % with 1500 packets
- The wanted signal is set to -67 dBm; the interferer levels are increased in the same time until the PER threshold is reached.
- Channels under the test: 0, 19, and 39

Results:

Table 13. Intermodulation

| | ch0 | ch0 | ch0 | ch0 | ch0 | ch0 |
|-------------------------|--------------|--------------|--------------|--------------|--------------|--------------|
| | 2402 | 2402 | 2402 | 2402 | 2402 | 2402 |
| | Low | Low | Low | Low | Low | Low |
| Interferer1 (CW) (MHz) | -5 | -4 | -3 | 3 | 4 | 5 |
| Interferer2 (Mod) (MHz) | -10 | -8 | -6 | 6 | 8 | 10 |
| Interferer level (dBm) | -15.0 | -18.0 | -19.0 | -18.7 | -18.7 | -18.2 |
| BLE limit (dBm) | -50 | -50 | -50 | -50 | -50 | -50 |
| Margin (dB) | 45.7 | 42.7 | 41.7 | 42.0 | 42.0 | 42.5 |

| | ch19 | ch19 | ch19 | ch19 | ch19 | ch19 |
|-------------------------|--------------|--------------|--------------|--------------|--------------|--------------|
| | 2440 | 2440 | 2440 | 2440 | 2440 | 2440 |
| | Mid | Mid | Mid | Mid | Mid | Mid |
| Interferer1 (CW) (MHz) | -5 | -4 | -3 | 3 | 4 | 5 |
| Interferer2 (Mod) (MHz) | -10 | -8 | -6 | 6 | 8 | 10 |
| Interferer level (dBm) | -16.0 | -18.0 | -19.0 | -19.0 | -18.7 | -18.2 |
| BLE limit (dBm) | -50 | -50 | -50 | -50 | -50 | -50 |
| Margin (dB) | 44.7 | 42.7 | 41.7 | 41.7 | 42.0 | 42.5 |

| | ch39 | ch39 | ch39 | ch39 | ch39 | ch39 |
|-------------------------|--------------|--------------|--------------|--------------|--------------|--------------|
| | 2480 | 2480 | 2480 | 2480 | 2480 | 2480 |
| | High | High | High | High | High | High |
| Interferer1 (CW) (MHz) | -5 | -4 | -3 | 3 | 4 | 5 |
| Interferer2 (Mod) (MHz) | -10 | -8 | -6 | 6 | 8 | 10 |
| Interferer level (dBm) | -17.5 | -18.0 | -18.7 | -19.2 | -18.7 | -18.4 |
| BLE limit (dBm) | -50 | -50 | -50 | -50 | -50 | -50 |
| Margin (dB) | 43.2 | 42.7 | 42.0 | 41.5 | 42.0 | 42.3 |

Conclusion:

- Good margin, in line with the expected results

3.3. Return loss

3.3.1. RF path with matching components

The measurements are done using the SMA connector. Therefore, the C57 capacitor is mounted and the C55 capacitor is not mounted.

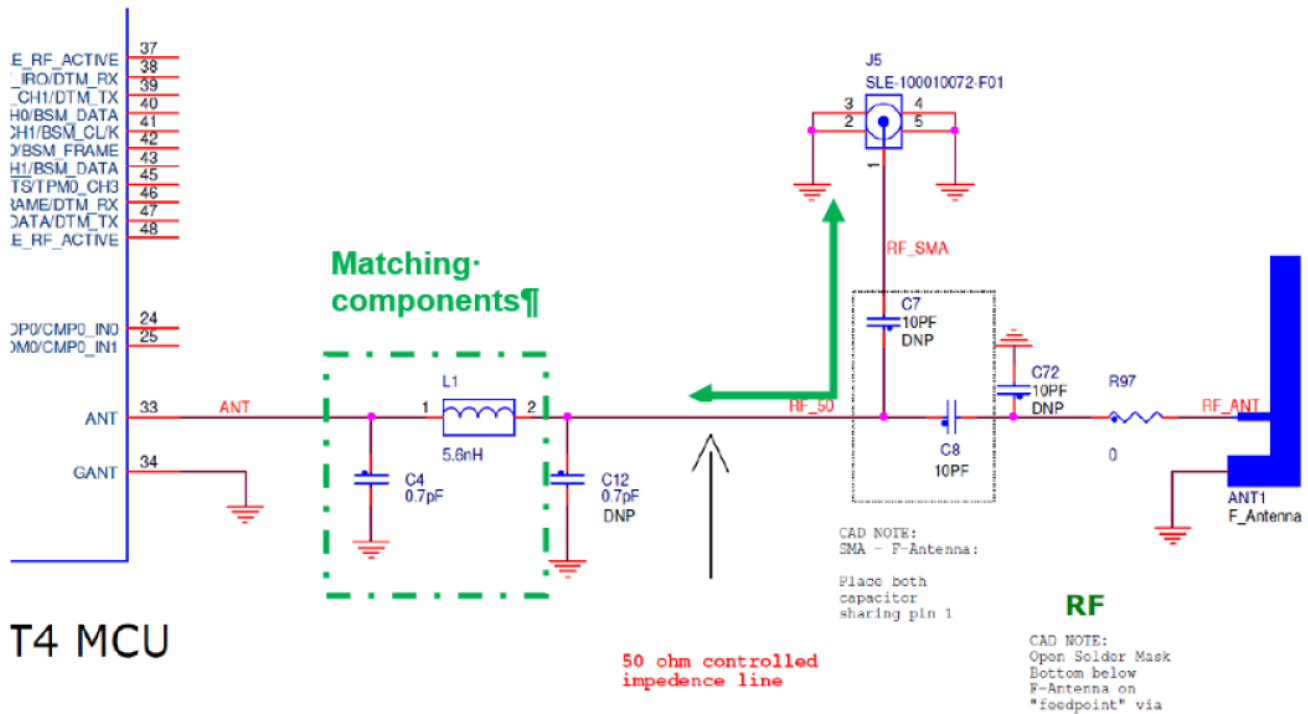

Figure 31. RF matching

The matching components are:

- L2 = 5.6 nH

Table 14. L2 component matching

| Description | Mfr. name | Mfr. part number |
|--|-----------|------------------|
| IND -- 0.0056 μH @ 500 MHz 300 mA +/-0.1 nH 0402 | MURATA | LQP15MN5N6B02 |

- C50 = 0.7 pF

Table 15. C50 component matching

| Description | Mfr. name | Mfr. part number |
|-------------------------------------|-----------|--------------------|
| CAP CER 0.7 pF 50 V 0.1 pF C0G 0402 | MURATA | GRM1555C1HR70BA01D |

3.3.2. RX

NOTE

In the Rx mode, the return loss measurement is performed by setting the LNA gain of the KW41Z to the maximum.

Hardware:

- FRDM-KW41z rev.C1

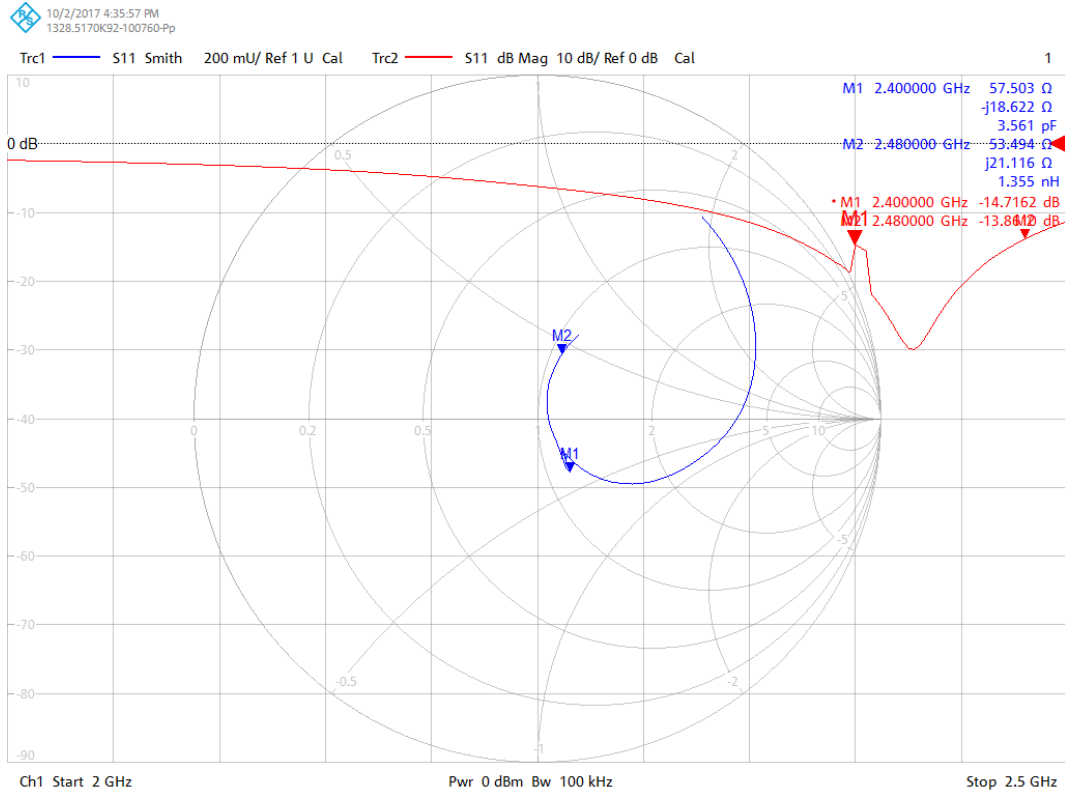

Figure 32. S11 diagram (Rx mode)

Results:

- Return loss: -14.7 (2.4 GHz) < S11 < -13.8 dB (2.48 GHz)

NOTE

There is no specification for the return loss.

Conclusion:

- The return loss (S11) is lower than -10 dB

3.3.3. TX

NOTE

In the Tx mode, the return loss measurement is performed by setting the KW41Z RF output power to the minimum.

Hardware:

- FRDM-KW41z rev.C1

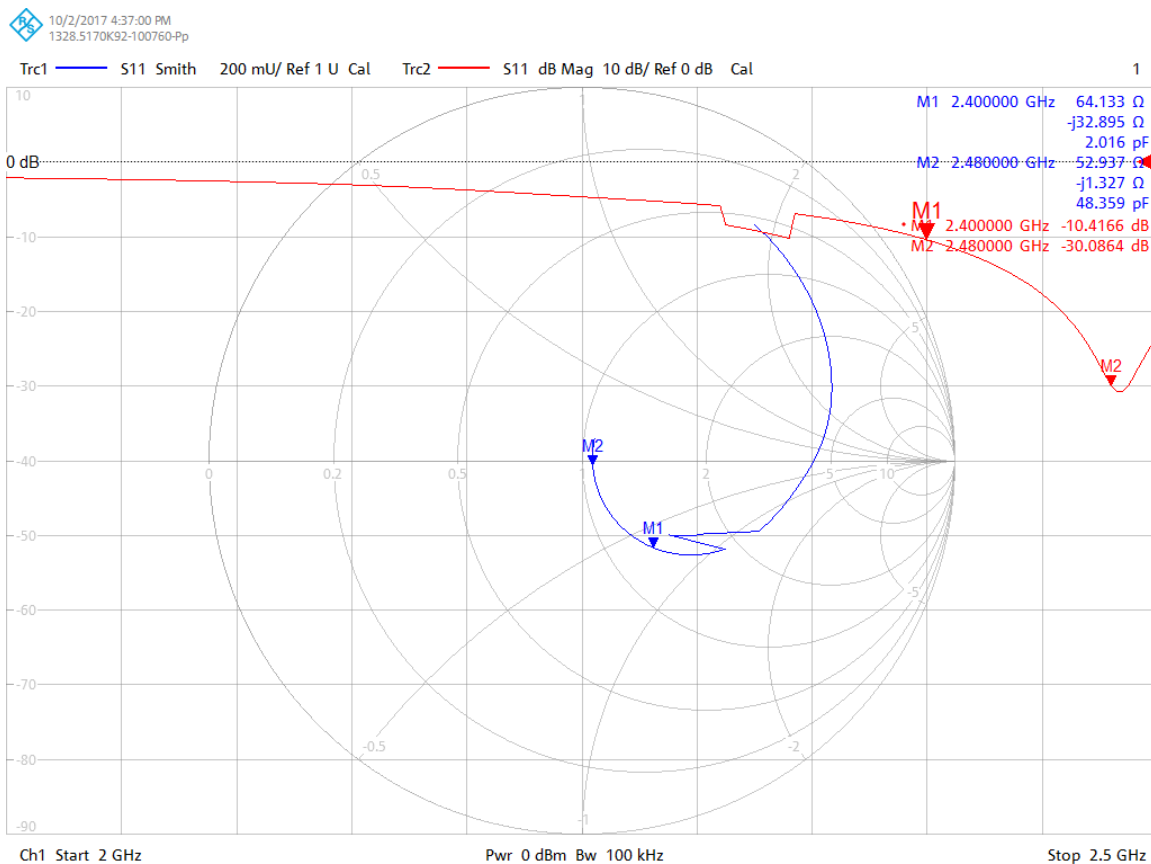

Figure 33. S11 diagram (Tx mode)

Results:

- Return loss: -30 (2.48 GHz) $< S_{11} < -10.4$ dB (2.4 GHz)

NOTE

There is no specification for the return loss.

Conclusion:

- The return loss (S_{11}) is lower than -10 dB

4. Radiated tests

4.1. RX test setup

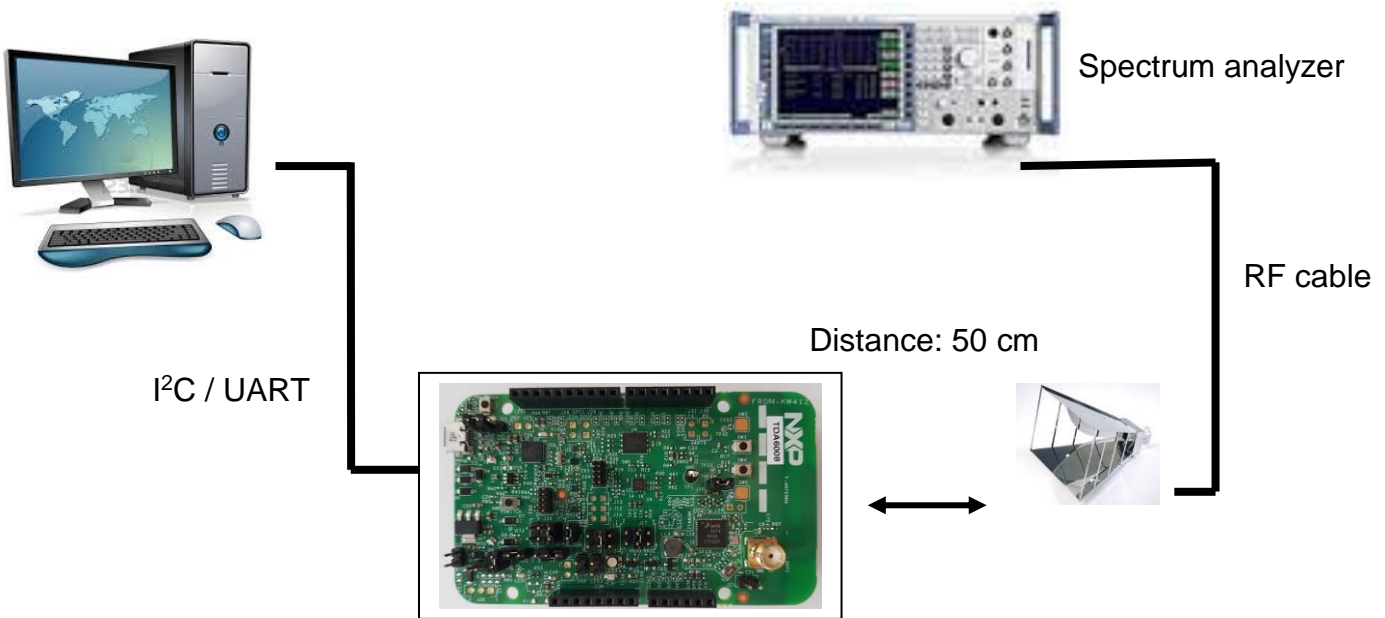

Figure 34. Radiated Rx test setup

During the radiated measurements, only the printed antenna (IFA type) is considered.

A receive antenna with a known gain is placed 50 cm from the FRDM-KW41Z antenna. The receive antenna (horn) is connected to the spectrum analyzer.

The Rx signal is measured in the same way as in the conducted measurements.

4.2. RX spurious

Test method:

- Set the radio to:
 - Receiver mode, frequency: channel 19
- Set the analyzer to:
 - Ref amp = - 20 dBm, Trace = max hold, detector = max peak
 - Start/stop frequency: 10 MHz/1 GHz
 - RBW = 100 kHz
 - Then set the start/stop frequency: 1 GHz/30 GHz
 - RBW = 1 MHz

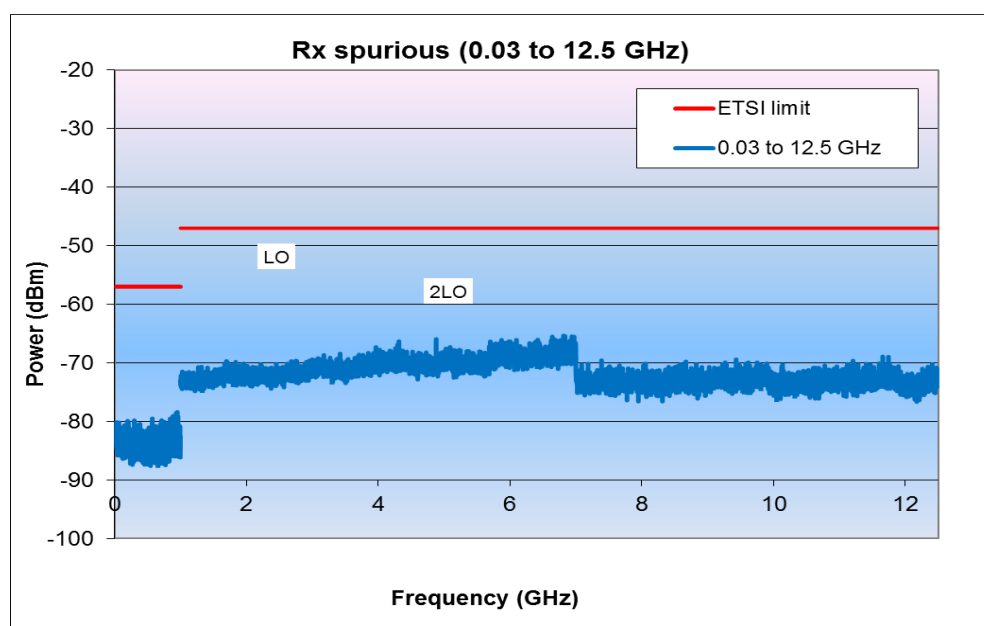

Figure 35. Conducted Rx spurious 30 MHz – 12.5 GHz

Conclusion:

- There are no spurs above the spectrum analyzer noise floor except for the 2xLO frequency which is under the ETSI limit with a 19-dB margin (conducted mode)
- In the radiated mode, the 2xLO is significant and the margin falls to 0 dBm
- It is strictly recommended to copy-paste the RF part of the FRDM-KW41Z rev.C1 layout
- The recommendation to decrease the 2xLO leakage is in the *Hardware Design Considerations for MKW41Z/31Z/21Z BLE and IEEE 802.15.4 Devices* (document [AN5377](#))

5. Antenna measurements

5.1. Return loss

The measurement of the return loss antenna (S11) is performed by disconnecting the C55 and C57 capacitors and making a connection marked by the green line in Figure 36 (antenna links to the SMA only).

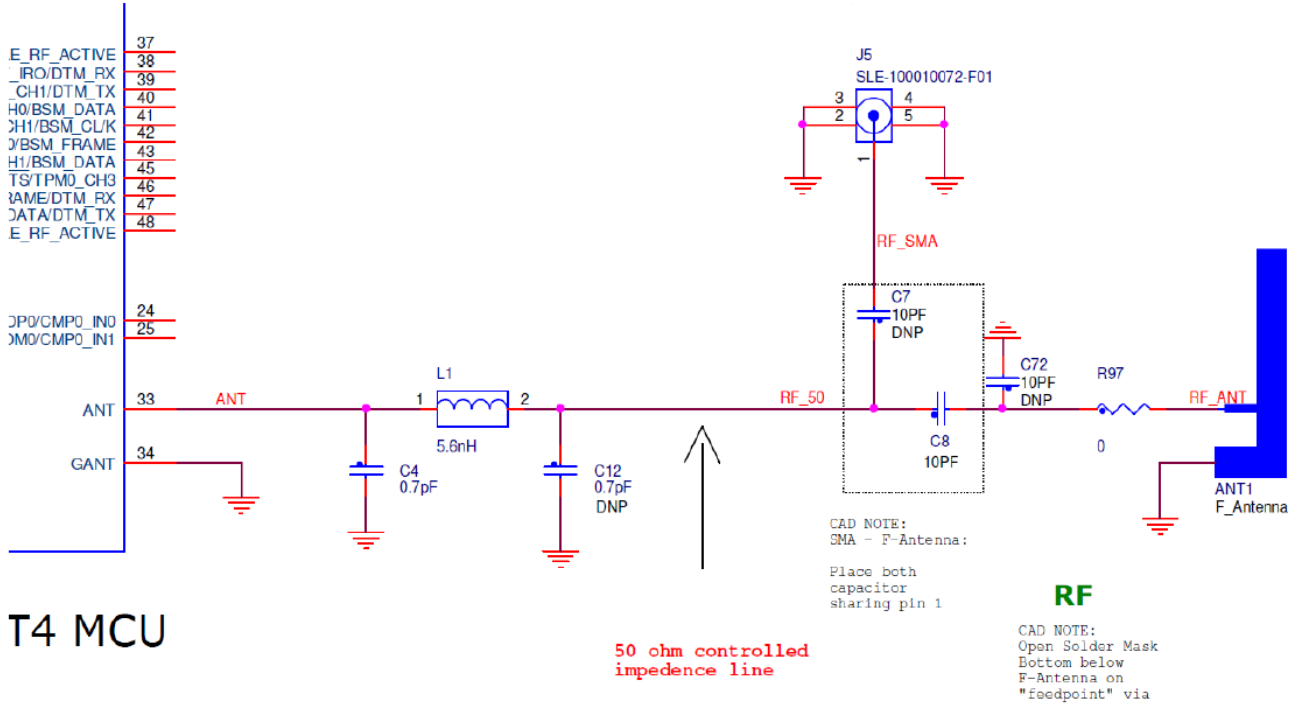

Figure 36. RF path connection (S11 antenna)

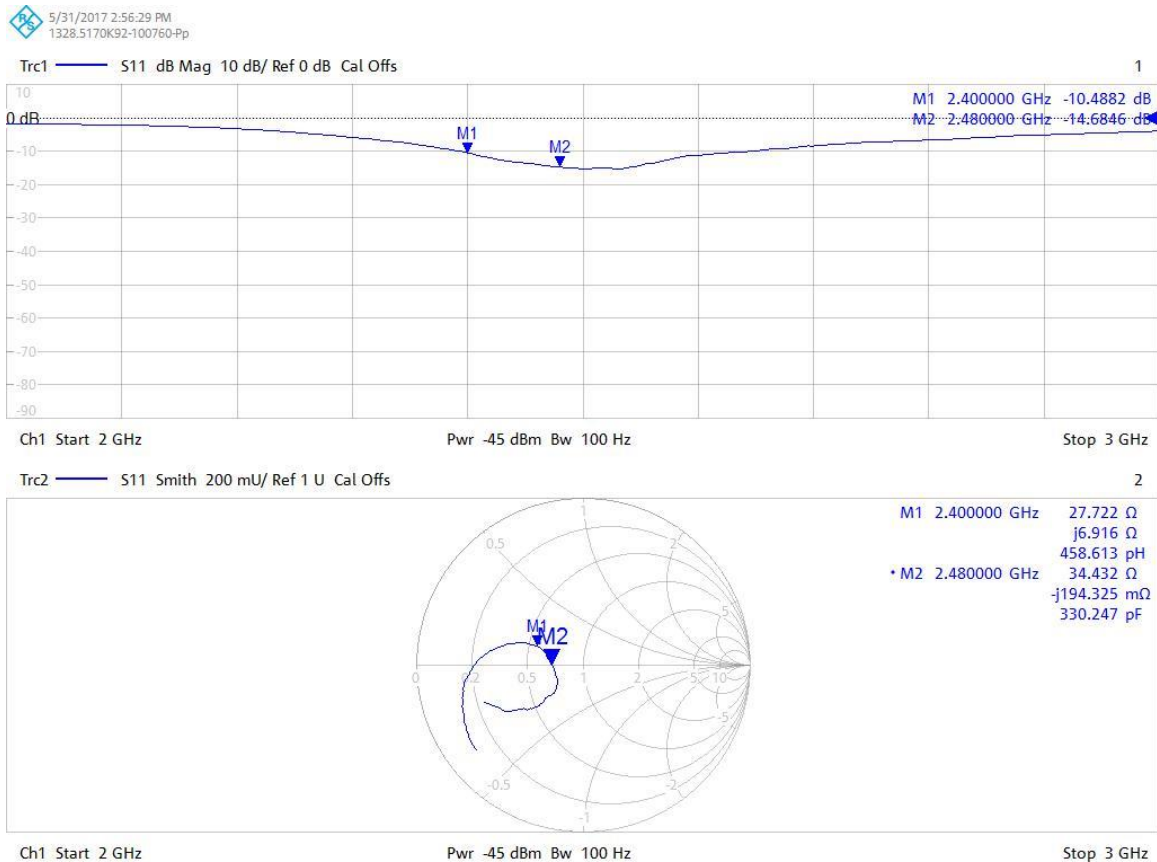

Figure 37. Antenna return loss (S11)

Results:

- Return loss: -10.5 (2.4 GHz) $< S_{11} < -14.7$ dB (2.48 GHz)

NOTE

There is no specification for the return loss.

Conclusion:

- The return loss (S11) is lower than -10 dB

6. Conclusion

Beyond the RED and BLE 4.2 compliances, these radio tests prove a good performance of the KW41Z wireless MCU.

7. References

- **ETS EN 300 328:** European Telecommunication Standard—Radio Equipment and Systems (RES) wideband data transmission systems, technical characteristics, and test conditions for data transmission equipment operating in the 2.4-GHz ISM band and using spread spectrum modulation techniques.
- **RF-PHY TS 4.2.0:** Bluetooth Test Specification. This document defines the test structures and procedures for the qualification testing of the Bluetooth implementations of the Bluetooth Low Energy RF PHY.
- **FCC Part 15:** Operation to FCC Part 15 is subject to two conditions. Firstly, the device may not cause harmful interference and, secondly, the device must accept any interference received, including interference that may cause undesired operation. Hence, there is no guaranteed quality of service when operating a Part 15 device.

8. Revision history

Table summarizes the changes done to this document since its initial release.

Table 16. Revision history

| Revision number | Date | Substantial changes |
|-----------------|---------|---|
| 0 | 10/2017 | Initial release |
| 1 | 11/2017 | Added Section 1.3, "List of equipment" . Updated various figures and tables. |

How to Reach Us:

Home Page:

nxp.com

Web Support:

nxp.com/support

Information in this document is provided solely to enable system and software implementers to use NXP products. There are no express or implied copyright licenses granted hereunder to design or fabricate any integrated circuits based on the information in this document. NXP reserves the right to make changes without further notice to any products herein.

NXP makes no warranty, representation, or guarantee regarding the suitability of its products for any particular purpose, nor does NXP assume any liability arising out of the application or use of any product or circuit, and specifically disclaims any and all liability, including without limitation consequential or incidental damages. "Typical" parameters that may be provided in NXP data sheets and/or specifications can and do vary in different applications, and actual performance may vary over time. All operating parameters, including "typicals," must be validated for each customer application by customer's technical experts. NXP does not convey any license under its patent rights nor the rights of others. NXP sells products pursuant to standard terms and conditions of sale, which can be found at the following address:

nxp.com/SalesTermsandConditions.

NXP, the NXP logo, NXP SECURE CONNECTIONS FOR A SMARTER WORLD, Freescale, the Freescale logo, and Kinetis are trademarks of NXP B.V. All other product or service names are the property of their respective owners.

Arm, the Arm logo, and Cortex are registered trademarks of ARM Limited (or its subsidiaries) in the EU and/or elsewhere. Bluetooth is a registered trademark of Bluetooth SIG, Inc. All rights reserved.

© 2017 NXP B.V.

Document Number: AN12059
Rev. 1
11/2017

